

M378A5244BB0
M378A1K43BB1
M378A1K43BB2
M378A2K43BB1

288pin Unbuffered DIMM based on 8Gb B-die

78FBGA with Lead-Free & Halogen-Free
(RoHS compliant)

datasheet

SAMSUNG ELECTRONICS RESERVES THE RIGHT TO CHANGE PRODUCTS, INFORMATION AND SPECIFICATIONS WITHOUT NOTICE.

Products and specifications discussed herein are for reference purposes only. All information discussed herein is provided on an "AS IS" basis, without warranties of any kind.

This document and all information discussed herein remain the sole and exclusive property of Samsung Electronics. No license of any patent, copyright, mask work, trademark or any other intellectual property right is granted by one party to the other party under this document, by implication, estoppel or otherwise.

Samsung products are not intended for use in life support, critical care, medical, safety equipment, or similar applications where product failure could result in loss of life or personal or physical harm, or any military or defense application, or any governmental procurement to which special terms or provisions may apply.

For updates or additional information about Samsung products, contact your nearest Samsung office.

All brand names, trademarks and registered trademarks belong to their respective owners.

© 2018 Samsung Electronics Co., Ltd. All rights reserved.

Revision History

| <u>Revision No.</u> | <u>History</u> | <u>Draft Date</u> | <u>Remark</u> | <u>Editor</u> |
|---------------------|--|-------------------|---------------|---------------------|
| 1.0 | - First SPEC release | Feb. 2015 | - | J.Y.Lee |
| 1.1 | - Addition of VDDSPD tolerance on page 8 - Change of Function Block Diagram (without thermal sensor) on page 11 | Mar. 2015 | - | J.Y.Lee |
| 1.2 | - Deletion of "x64 DIMM Pin Configuration" - Correction of typo | Apr. 2015 | - | J.Y.Lee |
| 1.21 | - Correction of typo | Apr. 2015 | - | J.Y.Lee |
| 1.3 | - Addition of Module line up (M378A1K43BB1) | May. 2015 | - | J.Y.Lee |
| 1.31 | - Correction of typo | May. 2015 | - | J.Y.Lee |
| 1.32 | - Correction of typo | Jul. 2015 | - | J.Y.Lee |
| 1.4 | - Change of VDDSPD tolerance on page 7 | 5th Nov. 2015 | - | J.Y.Lee |
| 1.5 | - 1Rx8 2400 Jedec MDL gerber Change : 1->2 - Change of IDD value on page 26~28 | 4th Feb. 2016 | - | J.Y.Lee |
| 1.51 | - Correction of typo | 4th Mar. 2016 | - | J.Y.Lee |
| 1.6 | - Addition of Module line up (M378A5244BB0) | 4th Apr. 2016 | - | J.Y.Lee |
| 1.7 | - Addition of 8GB line-up | 28th Apr. 2016 | - | J.Y.Lee |
| 1.8 | - Addition of IDD value (M378A5244BB0) | 4th May. 2016 | - | J.Y.Lee |
| 1.9 | - Deletion of Function Block Diagram [M378A1K43BB1] on page 11 - Correction of typo | 29th Jun. 2016 | - | J.Y.Lee |
| 2.0 | - Addition of DDR4-2666 (M378A5244BB0, M378A1K43BB2, M378A2K43BB1) | 18th Nov. 2016 | - | J.Y.Lee |
| 2.1 | - Change of Physical Dimensions on page 46~51 | 22th Mar. 2017 | - | J.Y.Lee |
| 2.2 | - Add M391A1K43BB2-CTD. - Update JEDEC datasheet for 79-4B. 1. Update INPUT/OUTPUT FUNCTIONAL DESCRIPTION. 2. Update Single-ended AC & DC Input Levels for Command and Address table. 3. Update Basic IDD, IPP and IDDQ Measurement Conditions table. 4. Add IDD and IDDQ Specification for M391A1K43BB2. 5. Add IDD and IDDQ Specification for M391A2K43BB1 2666Mpbs. 6. Update ELECTRICAL CHARACTERISTICS AND AC TIMING. 7. Update Timing Parameters by Speed Grade. 8. Add physical dimension for 1Gx8 based 1Gx72 Module (1 Rank) - M391A1K43BB2. | 28th Sep, 2017 | Final | J.Y.Bae |
| 2.3 | - Remove codes for M391%. | 15th Nov, 2017 | Final | J.Y.Bae J.H.Han |
| 2.4 | - Correct typo in Key features. - Update Single-ended AC & DC Input Levels for Command and Address table. - Update Differential AC and DC Input Levels table. - Update Single-ended Levels for CK_t, CK_c table. | 27th Apr, 2018 | Final | C.M.Kang J.Y.Bae |

| <u>Revision No.</u> | <u>History</u> | <u>Draft Date</u> | <u>Remark</u> | <u>Editor</u> |
|---------------------|---|-------------------|---------------|---------------|
| | <ul style="list-style-type: none"> - Add Address, Command and Control Overshoot and Undershoot specifications. - Add Data, Strobe and Mask Overshoot and Undershoot Specifications. - Update Cross Point Voltage for Differential Input Signals (CK) - Add CMOS rail to rail Input Levels. - Add AC and DC Logic Input Levels for DQS Signals. - Add Peak voltage calculation method. - Add Differential Input Cross Point Voltage (DQS). - Add Differential Input Slew Rate Definition DQS). - Add AC AND DC OUTPUT MEASUREMENT LEVELS. - Correct Single-ended AC & DC Output Levels table. - Update Speed Bin Table Note. - Update Timing parameters by speed grade. - Add Rounding Algorithms. - Add The DQ input receiver compliance mask for voltage and timing. - Add Command, Control, and Address Setup, Hold, and Derating. - Add DDR4 Function Matrix | | | |

Table Of Contents

288pin Unbuffered DIMM based on 8Gb B-die

| | |
|---|----|
| 1. DDR4 Unbuffered DIMM ORDERING INFORMATION | 6 |
| 2. KEY FEATURES | 6 |
| 3. ADDRESS CONFIGURATION | 6 |
| 4. Unbuffered DIMM PIN CONFIGURATIONS (Front side/Back side)..... | 7 |
| 5. PIN DESCRIPTION | 8 |
| 6. INPUT/OUTPUT FUNCTIONAL DESCRIPTION | 9 |
| 6.1 Address Mirroring | 11 |
| 7. FUNCTION BLOCK DIAGRAM: | 12 |
| 7.1 4GB, 512Mx64 Non ECC Module (Populated as 1 rank of x16 DDR4 SDRAMs)..... | 12 |
| 7.2 8GB, 1Gx64 Non ECC Module (Populated as 1 rank of x8 DDR4 SDRAMs) | 13 |
| 7.3 16GB, 2Gx64 Non ECC Module (Populated as 2 ranks of x8 DDR4 SDRAMs) | 14 |
| 8. ABSOLUTE MAXIMUM RATINGS | 16 |
| 9. AC & DC OPERATING CONDITIONS | 16 |
| 10. AC & DC INPUT MEASUREMENT LEVELS..... | 17 |
| 10.1 AC & DC Logic Input Levels for Single-Ended Signals..... | 17 |
| 10.2 AC and DC Input Measurement Levels: VREF Tolerances..... | 17 |
| 10.3 AC and DC Logic Input Levels for Differential Signals | 18 |
| 10.3.1. Differential Signals Definition | 18 |
| 10.3.2. Differential Swing Requirements for Clock (CK _t - CK _c)..... | 18 |
| 10.3.3. Single-ended Requirements for Differential Signals | 19 |
| 10.3.4. Address, Command and Control Overshoot and Undershoot specifications..... | 20 |
| 10.3.5. Clock Overshoot and Undershoot Specifications..... | 21 |
| 10.3.6. Data, Strobe and Mask Overshoot and Undershoot Specifications | 22 |
| 10.4 Slew Rate Definitions..... | 23 |
| 10.4.1. Slew Rate Definitions for Differential Input Signals (CK) | 23 |
| 10.4.2. Slew Rate Definition for Single-ended Input Signals (CMD/ADD) | 24 |
| 10.5 Differential Input Cross Point Voltage | 25 |
| 10.6 CMOS rail to rail Input Levels | 26 |
| 10.6.1. CMOS rail to rail Input Levels for RESET _n | 26 |
| 10.7 AC and DC Logic Input Levels for DQS Signals | 27 |
| 10.7.1. Differential signal definition | 27 |
| 10.7.2. Differential swing requirements for DQS (DQS _t - DQS _c)..... | 27 |
| 10.7.3. Peak voltage calculation method | 28 |
| 10.7.4. Differential Input Cross Point Voltage | 29 |
| 10.7.5. Differential Input Slew Rate Definition | 30 |
| 11. AC AND DC OUTPUT MEASUREMENT LEVELS | 31 |
| 11.1 Output Driver DC Electrical Characteristics..... | 31 |
| 11.1.1. Alert _n output Drive Characteristic | 33 |
| 11.1.2. Output Driver Characteristic of Connectivity Test (CT) Mode..... | 34 |
| 11.2 Single-ended AC & DC Output Levels..... | 35 |
| 11.3 Differential AC & DC Output Levels..... | 35 |
| 11.4 Single-ended Output Slew Rate | 36 |
| 11.5 Differential Output Slew Rate | 37 |
| 11.6 Single-ended AC & DC Output Levels of Connectivity Test Mode | 38 |
| 11.7 Test Load for Connectivity Test Mode Timing | 39 |
| 12. SPEED BIN | 40 |
| 12.1 Speed Bin Table Note..... | 45 |
| 13. IDD AND IDDQ SPECIFICATION PARAMETERS AND TEST CONDITIONS | 46 |
| 13.1 IDD, IPP and IDDQ Measurement Conditions | 46 |
| 14. IDD SPEC TABLE | 61 |
| 15. INPUT/OUTPUT CAPACITANCE | 65 |
| 16. ELECTRICAL CHARACTERISTICS & AC TIMING | 66 |
| 16.1 Reference Load for AC Timing and Output Slew Rate | 66 |
| 16.2 tREFI..... | 66 |
| 16.3 Clock Specification | 67 |
| 16.3.1. Definition for tCK(abs)..... | 67 |
| 16.3.2. Definition for tCK(avg)..... | 67 |
| 16.3.3. Definition for tCH(avg) and tCL(avg)..... | 67 |
| 16.3.4. Definition for tERR(nper)..... | 67 |
| 17. TIMING PARAMETERS BY SPEED GRADE | 68 |

17.1 Rounding Algorithms74

17.2 The DQ input receiver compliance mask for voltage and timing75

17.3 Command, Control, and Address Setup, Hold, and Derating79

17.4 DDR4 Function Matrix81

18. PHYSICAL DIMENSIONS83

18.1 512Mbx16 based 512Mx64 Module (1 Rank) - M378A5244BB083

18.2 1Gx8 based 1Gx64 Module (1 Rank) - M378A1K43BB184

18.3 1Gx8 based 1Gx64 Module (1 Rank) - M378A1K43BB285

18.4 1Gx8 based 2Gx64 Module (2 Ranks) - M378A2K43BB186

1. DDR4 Unbuffered DIMM ORDERING INFORMATION

[Table 1] Ordering Information Table

| Part Number ²⁾ | Density | Organization | Component Composition ¹⁾ | Number of Rank | Height |
|---------------------------|---------|--------------|-------------------------------------|----------------|---------|
| M378A5244BB0-CPB/RC/TD | 4GB | 512Mx64 | 512Mx16(K4A8G165WB-BC##)*4 | 1 | 31.25mm |
| M378A1K43BB1-CPB | 8GB | 1Gx64 | 1Gx8(K4A8G085WB-BCPB)*8 | 1 | 31.25mm |
| M378A1K43BB2-CRC/TD | 8GB | 1Gx64 | 1Gx8(K4A8G085WB-BCRC/TD)*8 | 1 | 31.25mm |
| M378A2K43BB1-CPB/RC/TD | 16GB | 2Gx64 | 1Gx8(K4A8G085WB-BC##)*16 | 2 | 31.25mm |

NOTE :

1) "##" -PB/RC/TD

2) PB(2133Mbps 15-15-15)/RC(2400Mbps 17-17-17)/TD(2666Mbps 19-19-19)

- DDR4-2666(19-19-19) is backward compatible to lower frequency.

2. KEY FEATURES

[Table 2] Speed Bins

| Speed | DDR4-1600 | DDR4-1866 | DDR4-2133 | DDR4-2400 | DDR4-2666 | Unit |
|-------------|-----------|-----------|-----------|-----------|-----------|------|
| | 11-11-11 | 13-13-13 | 15-15-15 | 17-17-17 | 19-19-19 | |
| tCK(min) | 1.25 | 1.071 | 0.937 | 0.833 | 0.75 | ns |
| CAS Latency | 11 | 13 | 15 | 17 | 19 | nCK |
| tRCD(min) | 13.75 | 13.92 | 14.06 | 14.16 | 14.25 | ns |
| tRP(min) | 13.75 | 13.92 | 14.06 | 14.16 | 14.25 | ns |
| tRAS(min) | 35 | 34 | 33 | 32 | 32 | ns |
| tRC(min) | 48.75 | 47.92 | 47.06 | 46.16 | 46.25 | ns |

- JEDEC standard 1.2V ± 0.06V Power Supply
- V_{DDQ} = 1.2V ± 0.06V
- 800 MHz f_{CK} for 1600Mb/sec/pin, 933 MHz f_{CK} for 1866Mb/sec/pin, 1067MHz f_{CK} for 2133Mb/sec/pin, 1200MHz f_{CK} for 2400Mb/sec/pin, 1333MHz f_{CK} for 2666Mb/sec/pin
- 16 Banks (4 Bank Groups)
- Programmable CAS Latency: 10,11,12,13,14,15,16,17,18,19,20
- Programmable Additive Latency (Posted $\overline{\text{CAS}}$): 0, CL - 2, or CL - 1 clock
- Programmable CAS Write Latency (CWL) = 9,11 (DDR4-1600), 10,12 (DDR4-1866), 11,14 (DDR4-2133), 12,16 (DDR4-2400) and 14,18 (DDR4-2666)
- Burst Length: 8, 4 with tCCD = 4 which does not allow seamless read or write [either On the fly using A12 or MRS]
- Bi-directional Differential Data Strobe
- On Die Termination using ODT pin
- Average Refresh Period 7.8us at lower then T_{CASE} 85°C, 3.9us at 85°C < T_{CASE} ≤ 95°C
- Asynchronous Reset

3. ADDRESS CONFIGURATION

| Organization | Row Address | Column Address | Bank Group Address | Bank Address | Auto Precharge |
|---------------------------|-------------|----------------|--------------------|--------------|----------------|
| 512Mx16(8Gb) based Module | A0-A15 | A0-A9 | BG0 | BA0-BA1 | A10/AP |
| 1Gx8(8Gb) based Module | A0-A15 | A0-A9 | BG0-BG1 | BA0-BA1 | A10/AP |

4. Unbuffered DIMM PIN CONFIGURATIONS (Front side/Back side)

| Pin | Front | Pin | Back | Pin | Front | Pin | Back | Pin | Front | Pin | Back | Pin | Front | Pin | Back |
|-----|----------------------|-----|--------|-----|----------------------|-----|---------|-----|----------------------|-----|----------|-----|----------------------|-----|--------|
| 1 | NC | 145 | NC | 39 | VSS | 183 | DQ25 | 77 | VTT | 221 | VTT | 114 | VSS | 258 | DQ47 |
| 2 | VSS | 146 | VREFCA | 40 | DM3_n, DBI3_n, NC | 184 | VSS | KEY | | | | 115 | DQ42 | 259 | VSS |
| 3 | DQ4 | 147 | VSS | 41 | NC | 185 | DQS3_c | 78 | EVENT_n | 222 | PARITY | 116 | VSS | 260 | DQ43 |
| 4 | VSS | 148 | DQ5 | 42 | VSS | 186 | DQS3_t | 79 | A0 | 223 | VDD | 117 | DQ52 | 261 | VSS |
| 5 | DQ0 | 149 | VSS | 43 | DQ30 | 187 | VSS | 80 | VDD | 224 | BA1 | 118 | VSS | 262 | DQ53 |
| 6 | VSS | 150 | DQ1 | 44 | VSS | 188 | DQ31 | 81 | BA0 | 225 | A10/AP | 119 | DQ48 | 263 | VSS |
| 7 | DM0_n, DBI0_n, NC | 151 | VSS | 45 | DQ26 | 189 | VSS | 82 | RAS_n/A16 | 226 | VDD | 120 | VSS | 264 | DQ49 |
| 8 | NC | 152 | DQS0_c | 46 | VSS | 190 | DQ27 | 83 | VDD | 227 | RFU | 121 | DM6_n, DBI6_n, NC | 265 | VSS |
| 9 | VSS | 153 | DQS0_t | 47 | CB4, NC | 191 | VSS | 84 | CS0_n | 228 | WE_n/A14 | 122 | NC | 266 | DQS6_c |
| 10 | DQ6 | 154 | VSS | 48 | VSS | 192 | CB5, NC | 85 | VDD | 229 | VDD | 123 | VSS | 267 | DQS6_t |
| 11 | VSS | 155 | DQ7 | 49 | CB0, NC | 193 | VSS | 86 | CAS_n/A15 | 230 | NC | 124 | DQ54 | 268 | VSS |
| 12 | DQ2 | 156 | VSS | 50 | VSS | 194 | CB1, NC | 87 | ODT0 | 231 | VDD | 125 | VSS | 269 | DQ55 |
| 13 | VSS | 157 | DQ3 | 51 | DM8_n, DBI8_n, NC | 195 | VSS | 88 | VDD | 232 | A13 | 126 | DQ50 | 270 | VSS |
| 14 | DQ12 | 158 | VSS | 52 | NC | 196 | DQS8_c | 89 | CS1_n | 233 | VDD | 127 | VSS | 271 | DQ51 |
| 15 | VSS | 159 | DQ13 | 53 | VSS | 197 | DQS8_t | 90 | VDD | 234 | NC | 128 | DQ60 | 272 | VSS |
| 16 | DQ8 | 160 | VSS | 54 | CB6, NC | 198 | VSS | 91 | ODT1 | 235 | NC | 129 | VSS | 273 | DQ61 |
| 17 | VSS | 161 | DQ9 | 55 | VSS | 199 | CB7, NC | 92 | VDD | 236 | VDD | 130 | DQ56 | 274 | VSS |
| 18 | DM1_n, DBI1_n, NC | 162 | VSS | 56 | CB2, NC | 200 | VSS | 93 | NC | 237 | NC | 131 | VSS | 275 | DQ57 |
| 19 | NC | 163 | DQS1_c | 57 | VSS | 201 | CB3, NC | 94 | VSS | 238 | SA2 | 132 | DM7_n, DBI7_n, NC | 276 | VSS |
| 20 | VSS | 164 | DQS1_t | 58 | RESET_n | 202 | VSS | 95 | DQ36 | 239 | VSS | 133 | NC | 277 | DQS7_c |
| 21 | DQ14 | 165 | VSS | 59 | VDD | 203 | CKE1 | 96 | VSS | 240 | DQ37 | 134 | VSS | 278 | DQS7_t |
| 22 | VSS | 166 | DQ15 | 60 | CKE0 | 204 | VDD | 97 | DQ32 | 241 | VSS | 135 | DQ62 | 279 | VSS |
| 23 | DQ10 | 167 | VSS | 61 | VDD | 205 | RFU | 98 | VSS | 242 | DQ33 | 136 | VSS | 280 | DQ63 |
| 24 | VSS | 168 | DQ11 | 62 | ACT_n | 206 | VDD | 99 | DM4_n, DBI4_n, NC | 243 | VSS | 137 | DQ58 | 281 | VSS |
| 25 | DQ20 | 169 | VSS | 63 | BG0 | 207 | BG1 | 100 | NC | 244 | DQS4_c | 138 | VSS | 282 | DQ59 |
| 26 | VSS | 170 | DQ21 | 64 | VDD | 208 | ALERT_n | 101 | VSS | 245 | DQS4_t | 139 | SA0 | 283 | VSS |
| 27 | DQ16 | 171 | VSS | 65 | A12/BC_n | 209 | VDD | 102 | DQ38 | 246 | VSS | 140 | SA1 | 284 | VDDSPD |
| 28 | VSS | 172 | DQ17 | 66 | A9 | 210 | A11 | 103 | VSS | 247 | DQ39 | 141 | SCL | 285 | SDA |
| 29 | DM2_n, DBI2_n, NC | 173 | VSS | 67 | VDD | 211 | A7 | 104 | DQ34 | 248 | VSS | 142 | VPP | 286 | VPP |
| 30 | NC | 174 | DQS2_c | 68 | A8 | 212 | VDD | 105 | VSS | 249 | DQ35 | 143 | VPP | 287 | VPP |
| 31 | VSS | 175 | DQS2_t | 69 | A6 | 213 | A5 | 106 | DQ44 | 250 | VSS | 144 | RFU | 288 | VPP |
| 32 | DQ22 | 176 | VSS | 70 | VDD | 214 | A4 | 107 | VSS | 251 | DQ45 | | | | |
| 33 | VSS | 177 | DQ23 | 71 | A3 | 215 | VDD | 108 | DQ40 | 252 | VSS | | | | |
| 34 | DQ18 | 178 | VSS | 72 | A1 | 216 | A2 | 109 | VSS | 253 | DQ41 | | | | |
| 35 | VSS | 179 | DQ19 | 73 | VDD | 217 | VDD | 110 | DM5_n, DBI5_n, NC | 254 | VSS | | | | |
| 36 | DQ28 | 180 | VSS | 74 | CK0_t | 218 | CK1_t | 111 | NC | 255 | DQS5_c | | | | |
| 37 | VSS | 181 | DQ29 | 75 | CK0_c | 219 | CK1_c | 112 | VSS | 256 | DQS5_t | | | | |
| 38 | DQ24 | 182 | VSS | 76 | VDD | 220 | VDD | 113 | DQ46 | 257 | VSS | | | | |

5. PIN DESCRIPTION

| Pin Name | Description |
|------------------------------------|--|
| A0–A17 ¹⁾ | SDRAM address bus |
| BA0, BA1 | SDRAM bank select |
| BG0, BG1 | SDRAM bank group select |
| RAS_n ²⁾ | SDRAM row address strobe |
| CAS_n ³⁾ | SDRAM column address strobe |
| WE_n ⁴⁾ | SDRAM write enable |
| CS0_n, CS1_n | DIMM Rank Select Lines |
| CKE0, CKE1 | SDRAM clock enable lines |
| ODT0, ODT1 | SDRAM on-die termination control lines |
| ACT_n | SDRAM activate |
| DQ0–DQ63 | DIMM memory data bus |
| CB0–CB7 | DIMM ECC check bits |
| TDQS0_t–TDQS8_t TDQS0_c–TDQS8_c | Dummy loads for mixed populations of x4 based and x8 based RDIMMs. Not used on UDIMMs. |
| DQS0_t–DQS8_t | SDRAM data strobes (positive line of differential pair) |
| DQS0_c–DQS8_c | SDRAM data strobes (negative line of differential pair) |
| DM0_n–DM8_n, DBI0_n–DBI8_n | SDRAM data masks/data bus inversion (x8-based x64 DIMMs) |
| CK0_t, CK1_t | SDRAM clocks (positive line of differential pair) |
| CK0_c, CK1_c | SDRAM clocks (negative line of differential pair) |

NOTE :

- 1) Address A17 is not valid for x8 and x16 based SDRAMs. For UDIMMs this connection pin is NC.
- 2) RAS_n is a multiplexed function with A16.
- 3) CAS_n is a multiplexed function with A15.
- 4) WE_n is a multiplexed function with A14.

| Pin Name | Description |
|----------|---|
| SCL | I ² C serial bus clock for SPD-TSE |
| SDA | I ² C serial bus data line for SPD-TSE |
| SA0–SA2 | I ² C slave address select for SPD-TSE |
| PARITY | SDRAM parity input |
| VDD | SDRAM I/O and core power supply |
| 12 V | Optional power Supply on socket but not used on UDIMM |
| VREFCA | |
| VSS | Power supply return (ground) |
| VDDSPD | Serial SPD-TSE positive power supply |
| ALERT_n | SDRAM ALERT_n |
| VPP | SDRAM Supply |
| RESET_n | Set DRAMs to a Known State |
| EVENT_n | SPD signals a thermal event has occurred |
| VTT | SDRAM I/O termination supply |
| RFU | Reserved for future use |

[Table 3] Temperature Sensor Characteristics

| Grade | Range | Temperature Sensor Accuracy | | | Units | NOTE |
|------------|----------------|-----------------------------|---------|---------|---------|------|
| | | Min. | Typ. | Max. | | |
| B | 75 < Ta < 95 | - | +/- 0.5 | +/- 1.0 | °C | - |
| | 40 < Ta < 125 | - | +/- 1.0 | +/- 2.0 | | - |
| | -20 < Ta < 125 | - | +/- 2.0 | +/- 3.0 | | - |
| Resolution | | 0.25 | | | °C /LSB | - |

6. INPUT/OUTPUT FUNCTIONAL DESCRIPTION

| Symbol | Type | Function |
|---|------------------|---|
| CK_t, CK_c | Input | Clock: CK_t and CK_c are differential clock inputs. All address and control input signals are sampled on the crossing of the positive edge of CK_t and negative edge of CK_c. |
| CKE, (CKE1) | Input | Clock Enable: CKE HIGH activates and CKE LOW deactivates internal clock signals and device input buffers and output drivers. Taking CKE LOW provides Precharge Power-Down and Self-Refresh operation (all banks idle), or Active Power-Down (row Active in any bank). CKE is synchronous for Self-Refresh exit. After VREFCA and Internal DQ Vref have become stable during the power on and initialization sequence, they must be maintained during all operations (including Self-Refresh). CKE must be maintained high throughout read and write accesses. Input buffers, excluding CK_t, CK_c, ODT and CKE, are disabled during power-down. Input buffers, excluding CKE, are disabled during Self-Refresh. |
| CS_n (CS1_n) | Input | Chip Select: All commands are masked when CS_n is registered HIGH. CS_n provides for external Rank selection on systems with multiple Ranks. CS_n is considered part of the command code. CS2_n and CS3_n are not used on UDIMMs |
| C0, C1, C2 | Input | Chip ID: Chip ID is only used for 3DS for 2,4,8 high stack via TSV to select each slice of stacked component. Chip ID is considered part of the command code. Not used on UDIMMs. |
| ODT (ODT1) | Input | On Die Termination: ODT (registered HIGH) enables RTT_NOM termination resistance internal to the DDR4 SDRAM. When enabled, ODT is only applied to each DQ, DQS_t, DQS_c and DM_n/DBI_n/TDQS_t, NU/TDQS_c (When TDQS is enabled via Mode Register A11=1 in MR1) signal for x8 configurations. For x16 configuration ODT is applied to each DQ, DQSU_t, DQSU_c, DQSL_t, DQSL_c, DMU_n, and DML_n signal. The ODT pin will be ignored if MR1 is programmed to disable RTT_NOM. |
| ACT_n | Input | Activation Command Input: ACT_n defines the Activation command being entered along with CS_n. The input into RAS_n/A16, CAS_n/A15 and WE_n/A14 will be considered as Row Address A16, A15 and A14. |
| RAS_n/A16, CAS_n/A15, WE_n/A14 | Input | Command Inputs: RAS_n/A16, CAS_n/A15 and WE_n/A14 (along with CS_n) define the command being entered. Those pins have multi function. For example, for activation with ACT_n Low, these are Addresses like A16, A15 and A14 but for non-activation command with ACT_n High, these are Command pins for Read, Write and other command defined in command truth table. |
| DM_n/DBI_n/ TDQS_t, (DMU_n/ DBIU_n), (DML_n/ DBIL_n) | Input/ Output | Input Data Mask and Data Bus Inversion: DM_n is an input mask signal for write data. Input data is masked when DM_n is sampled LOW coincident with that input data during a Write access. DBI_n is an input/output identifying whether to store/output the true or inverted data. If DBI_n is LOW, the data will be stored/output after inversion inside the DDR4 SDRAM and not inverted if DBI_n is HIGH. TDQS is only supported in x8 SDRAM configurations. TDQS is not valid for UDIMMs. |
| BG0 - BG1 | Input | Bank Group Inputs: BG0 - BG1 define which bank group an Active, Read, Write or Precharge command is being applied. BG0 also determines which mode register is to be accessed during a MRS cycle. x4/x8 SDRAM configurations have BG0 and BG1. x16 based SDRAMs only have BG0. |
| BA0 - BA1 | Input | Bank Address Inputs: BA0 - BA1 define to which bank an Active, Read, Write or Precharge command is being applied. Bank address also determines which mode register is to be accessed during a MRS cycle. |
| A0 - A17 | Input | Address Inputs: Provide the row address for ACTIVATE Commands and the column address for Read/Write commands to select one location out of the memory array in the respective bank. A10/AP, A12/BC_n, RAS_n/A16, CAS_n/A15 and WE_n/A14 have additional functions. See other rows. The address inputs also provide the op-code during Mode Register Set commands. A17 is only defined for the x4 SDRAM configuration. |
| A10 / AP | Input | Auto-precharge: A10 is sampled during Read/Write commands to determine whether Autoprecharge should be performed to the accessed bank after the Read/Write operation. (HIGH: Autoprecharge; LOW: no Autoprecharge). A10 is sampled during a Precharge command to determine whether the Precharge applies to one bank (A10 LOW) or all banks (A10 HIGH). If only one bank is to be precharged, the bank is selected by bank addresses. |
| A12 / BC_n | Input | Burst Chop: A12/BC_n is sampled during Read and Write commands to determine if burst chop (on-the-fly) will be performed. (HIGH, no burst chop; LOW: burst chopped). See command truth table for details. |
| RESET_n | CMOS Input | Active Low Asynchronous Reset: Reset is active when RESET_n is LOW, and inactive when RESET_n is HIGH. RESET_n must be HIGH during normal operation. |
| DQ | Input/ Output | Data Input/ Output: Bi-directional data bus. If CRC is enabled via Mode register then CRC code is added at the end of Data Burst. Any DQ from DQ0-DQ3 may indicate the internal Vref level during test via Mode Register Setting MR4 A4=High. Refer to vendor specific data sheets to determine which DQ is used. |
| DQS_t, DQS_c, DQSU_t, DQSU_c, DQSL_t, DQSL_c | Input/ Output | Data Strobe: output with read data, input with write data. Edge-aligned with read data, centered in write data. For the x16, DQSL corresponds to the data on DQL0-DQL7; DQSU corresponds to the data on DQU0-DQU7. The data strobe DQS_t, DQSL_t and DQSU_t are paired with differential signals DQS_c, DQSL_c, and DQSU_c, respectively, to provide differential pair signaling to the system during reads and writes. DDR4 SDRAM supports differential data strobe only and does not support single-ended. |

| Symbol | Type | Function |
|-------------------|--------|--|
| TDQS_t, TDQS_c | Output | Termination Data Strobe: TDQS_t/TDQS_c are not valid for UDIMMs. |
| PAR | Input | Command and Address Parity Input: DDR4 Supports Even Parity check in DRAMs with MR setting. Once it's enabled via Register in MR5, then DRAM calculates Parity with ACT_n, RAS_n/A16, CAS_n/A15, WE_n/A14, BG0-BG1, BA0-BA1, A16-A0. LOW Command and address inputs shall have parity check performed when commands are latched via the rising edge of CK_t and when CS_n is low. |
| ALERT_n | Output | Alert: It has multi functions such as CRC error flag, Command and Address Parity error flag as Output signal. If there is error in CRC, then ALERT_n goes LOW for the period time interval and goes back HIGH. If there is error in Command Address Parity Check, then ALERT_n goes LOW for relatively long period until on going DRAM internal recovery transaction is complete. During Connectivity Test mode this pin functions as an input. Using this signal or not is dependent on the system. |
| TEN | Input | Connectivity Test Mode Enable : Required on X16 devices and optional input on x4/x8 with densities equal to or greater than 8Gb.HIGH in this pin will enable Connectivity Test Mode operation along with other pins. It is a CMOS rail to rail signal with AC high and low at 80% and 20% of VDD. Using this signal or not is dependent on System. This pin may be DRAM internally pulled low through a weak pull-down resistor to VSS |
| NC | | No Connect: No on DIMM electrical connection is present. |
| VDDQ | Supply | DQ Power Supply: 1.2 V +/- 0.06 V |
| VSSQ | Supply | DQ Ground |
| VDD | Supply | Power Supply: 1.2 V +/- 0.06 V |
| VSS | Supply | Ground |
| VPP | Supply | DRAM Activating Power Supply: 2.5V (2.375V min, 2.75V max) |
| 12 V | Supply | 12 V supply not used on UDIMMs. |
| VDDSPD | Supply | Power supply used to power the I2C bus on the SPD-TSE 2.5V or 3.3V. |
| VREFCA | Supply | Reference voltage for CA |
| ZQ | Supply | Reference Pin for ZQ calibration |

NOTE :

- 1) For PC4 VDD 1.2 V. For PC4L VDD is TBD.
- 2) For PC4 VTT is 0.60 V. For PC4L VTT is TBD.
- 3) Input only pins (BG0-BG1,BA0-BA1, A0-A17, ACT_n, RAS_n/A16, CAS_n/A15, WE_n/A14, CS_n, CKE, ODT, and RESET_n) do not supply termination.

6.1 Address Mirroring

DDR4 two rank UDIMMs will use address mirroring. DRAMs for even ranks will be placed on the front side of the module. DRAMs for odd ranks will be placed on the back side of the module. Wiring of the address bus will be as defined in Table .

Since the cross-wired pins have no secondary functions, there is no problem in normal operation. Any data written is read the same way. There are limitations however. When writing to the internal registers with a "load mode" operation, the specific address is required. This requires the controller to know if the rank is mirrored or not. There is a bit assignment in the SPD that indicates whether the module has been designed with the mirrored feature or not. See the DDR4 SPD specification for these details. The controller must read the SPD and have the capability of de-mirroring the address when accessing the odd ranks.

[Table 4] DIMM Wiring Definition for Address Mirroring

| Signal Name | DRAM Ball Label | | Comment |
|-------------|-----------------|-----------|---|
| | Connector | Even Rank | |
| A0 | A0 | A0 | |
| A1 | A1 | A1 | |
| A2 | A2 | A2 | |
| A3 | A3 | A4 | |
| A4 | A4 | A3 | |
| A5 | A5 | A6 | |
| A6 | A6 | A5 | |
| A7 | A7 | A8 | |
| A8 | A8 | A7 | |
| A9 | A9 | A9 | |
| A10/AP | A10/AP | A10/AP | |
| A11 | A11 | A13 | |
| A12/BC_n | A12/BC_n | A12/BC_n | |
| A13 | A13 | A11 | |
| A14/WE_n | A14/WE_n | A14/WE_n | |
| A15/CAS_n | A15/CAS_n | A15/CAS_n | |
| A16/RAS_n | A16/RAS_n | A16/RAS_n | |
| A17 | A17 | A17 | Not valid for x8 and x16 DRAM components up to 16Gb. |
| BA0 | BA0 | BA1 | |
| BA1 | BA1 | BA0 | |
| BG0 | BG0 | BG1 | BG1 is not valid for x16 DRAM components. For x16 DRAM components signal BG0 will be wired to DRAM ball BG0 for both ranks. |
| BG1 | BG1 | BG0 | BG1 is not valid for x16 DRAM components. For x16 DRAM components signal BG0 will be wired to DRAM ball BG0 for both ranks. |

7. FUNCTION BLOCK DIAGRAM:

7.1 4GB, 512Mx64 Non ECC Module (Populated as 1 rank of x16 DDR4 SDRAMs)

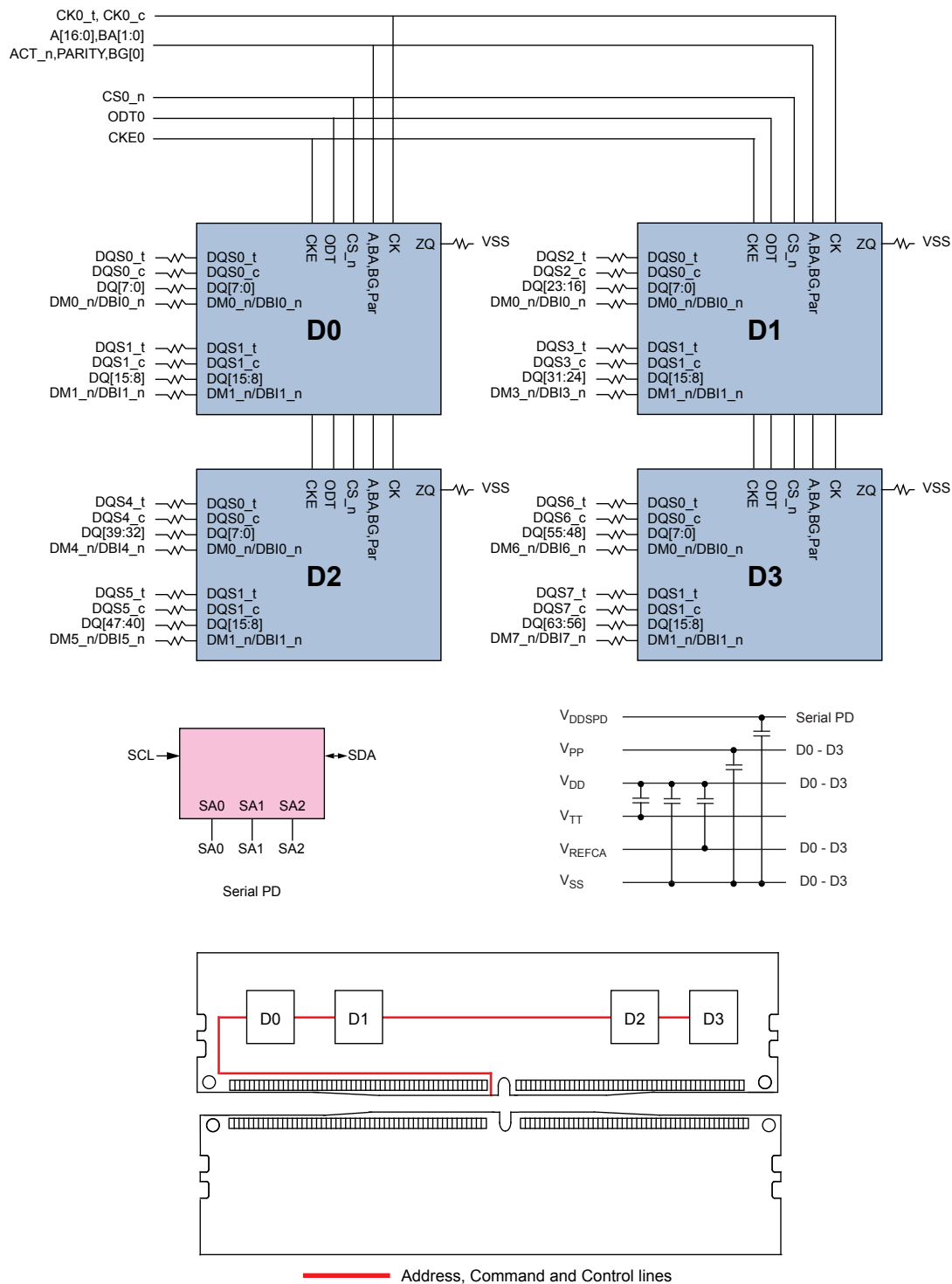

NOTE :
 1) Unless otherwise noted, resistor values are 15Ω ± 5%.
 2) ZQ resistors are 240Ω ± 1%. For all other resistor values refer to the appropriate wiring diagram.

7.2 8GB, 1Gx64 Non ECC Module (Populated as 1 rank of x8 DDR4 SDRAMs)

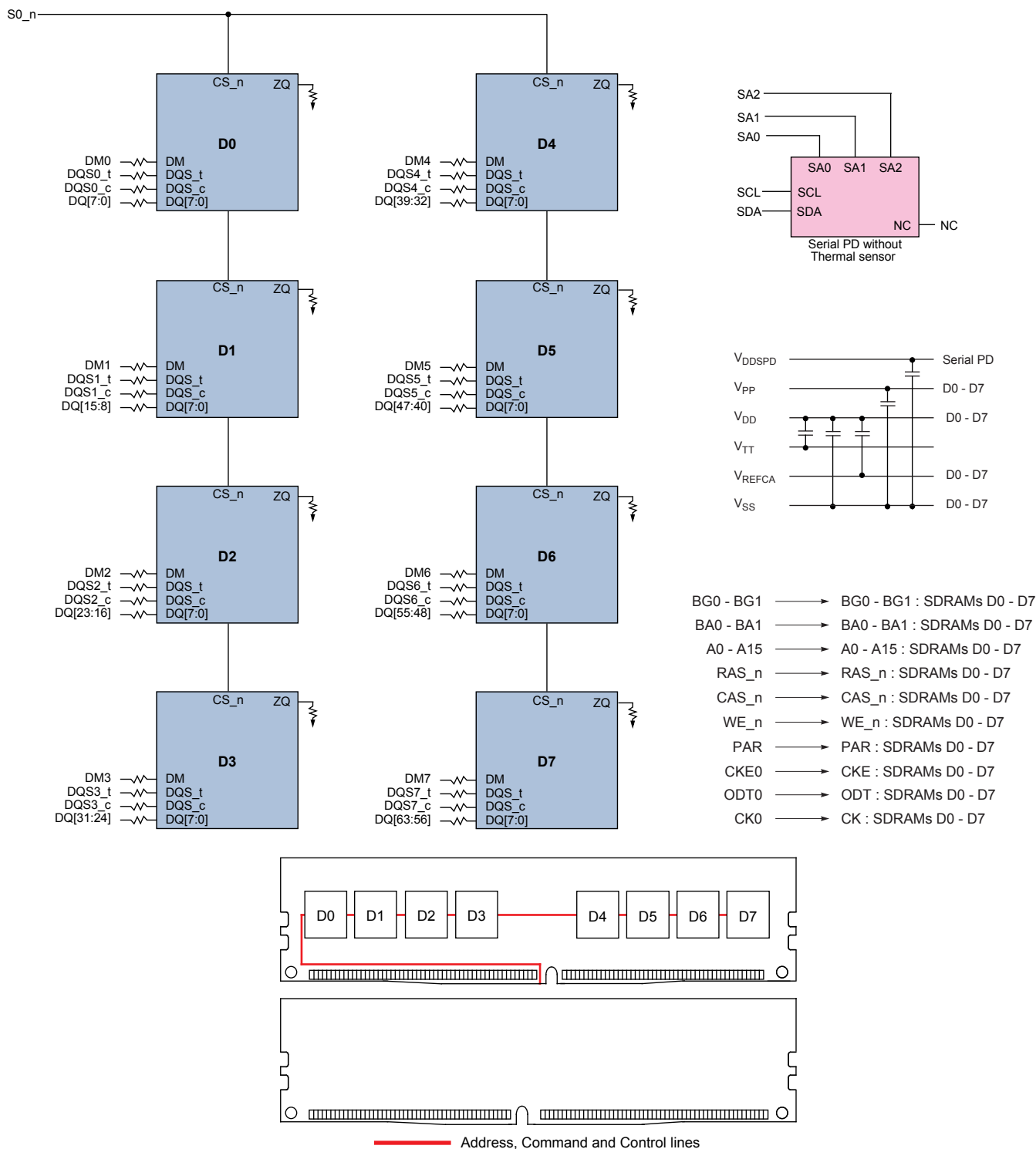

NOTE :
 1) Unless otherwise noted, resistor values are 15Ω ± 5%.
 2) See the Net Structure diagrams for all resistors associated with the command, address and control bus.
 3) ZQ resistors are 240Ω ± 1%. For all other resistor values refer to the appropriate wiring diagram.

7.3 16GB, 2Gx64 Non ECC Module (Populated as 2 ranks of x8 DDR4 SDRAMs)

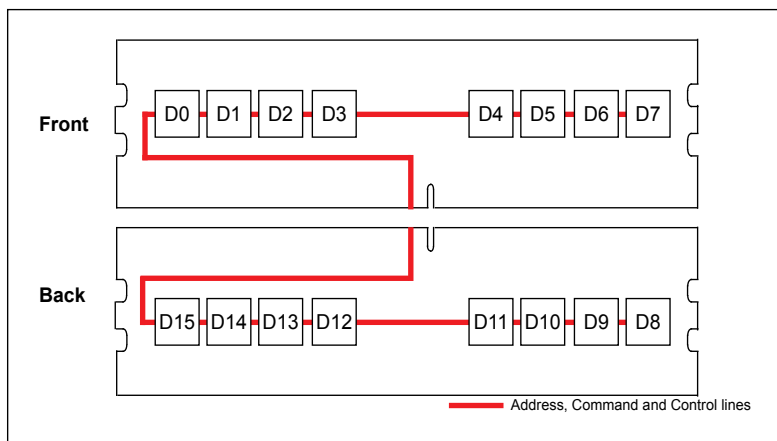
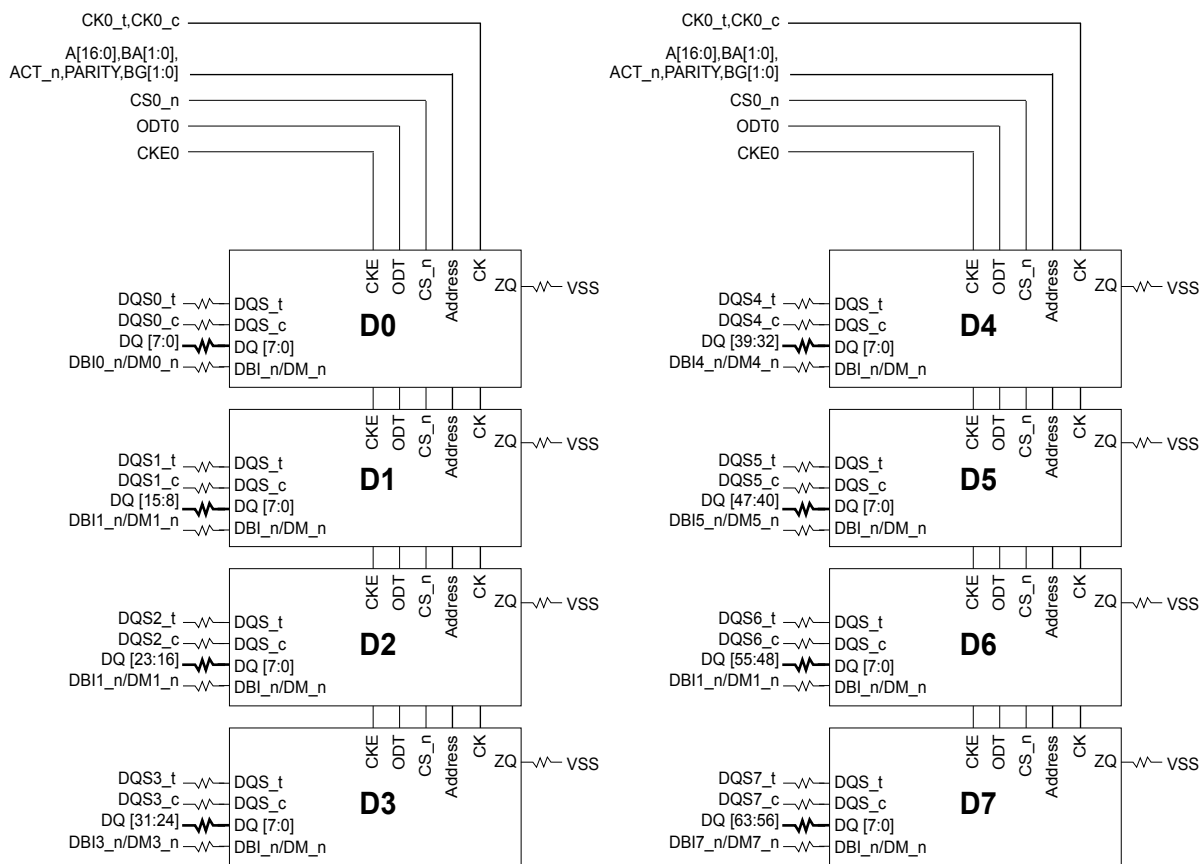

NOTE :
 1) Unless otherwise noted, resistor values are $15\Omega \pm 5\%$.
 2) ZQ resistors are $240\Omega \pm 1\%$. For all other resistor values refer to the appropriate wiring diagram.

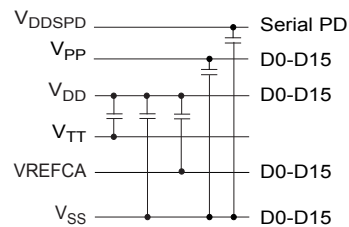
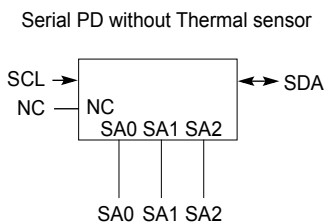
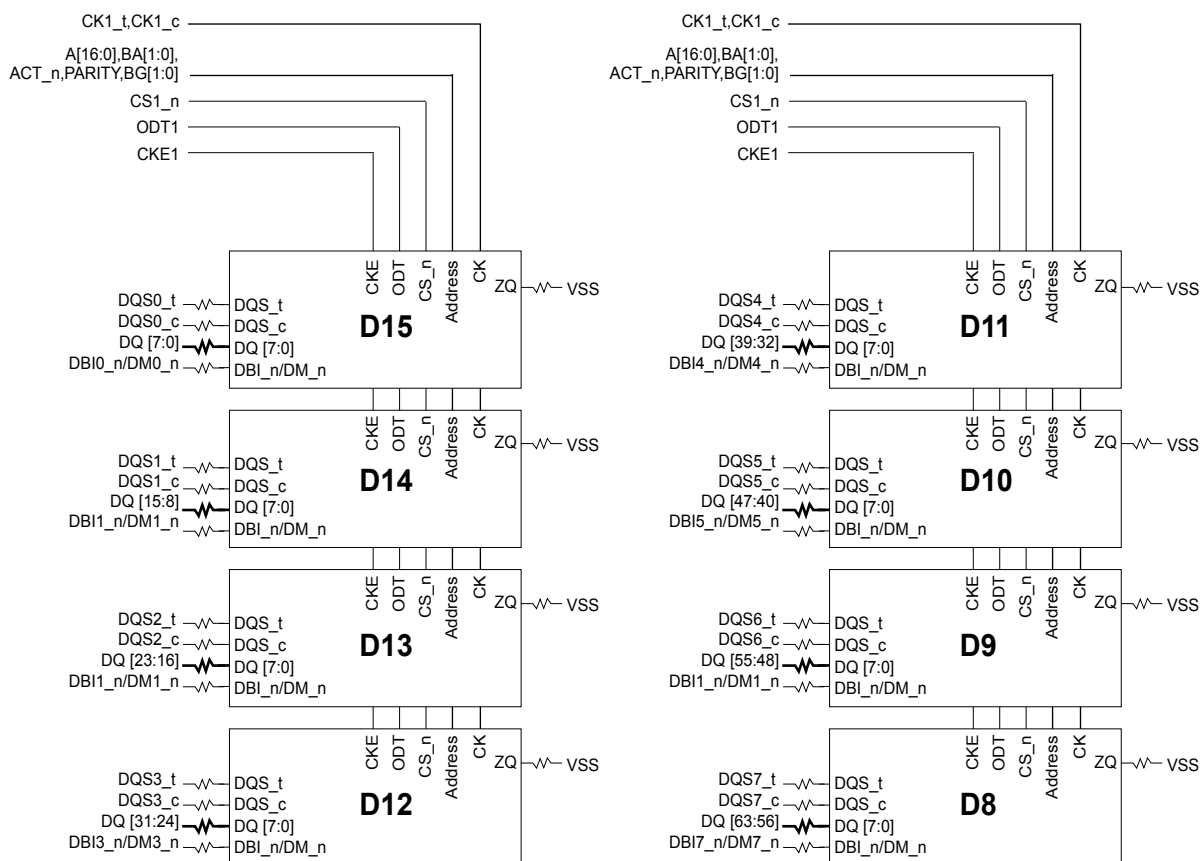

NOTE :

- 1) Unless otherwise noted, resistor values are 15W ± 5%.
- 2) ZQ resistors are 240W ± 1%. For all other resistor values refer to the appropriate wiring diagram.
- 3) For part 2 of 2 the DQ resistors are shown for simplicity but are the same physical components as shown on part 1 of 2.
- 4) EVENT_n is wired on this design. A standalone SPD may be used as well. No wiring changes are required.

8. ABSOLUTE MAXIMUM RATINGS

[Table 5] Absolute Maximum DC Ratings

| Symbol | Parameter | Rating | Units | NOTE |
|------------------------------------|--|-------------|-------|-------|
| VDD | Voltage on VDD pin relative to Vss | -0.3 ~ 1.5 | V | 1,3 |
| VDDQ | Voltage on VDDQ pin relative to Vss | -0.3 ~ 1.5 | V | 1,3 |
| VPP | Voltage on VPP pin relative to Vss | -0.3 ~ 3.0 | V | 4 |
| V _{IN} , V _{OUT} | Voltage on any pin except VREFCA relative to Vss | -0.3 ~ 1.5 | V | 1,3,5 |
| T _{STG} | Storage Temperature | -55 to +100 | °C | 1,2 |

NOTE :

- 1) Stresses greater than those listed under "Absolute Maximum Ratings" may cause permanent damage to the device. This is a stress rating only and functional operation of the device at these or any other conditions above those indicated in the operational sections of this specification is not implied. Exposure to absolute maximum rating conditions for extended periods may affect reliability
- 2) Storage Temperature is the case surface temperature on the center/top side of the DRAM. For the measurement conditions, please refer to JESD51-2 standard.
- 3) VDD and VDDQ must be within 300mV of each other at all times; and VREFCA must be not greater than 0.6 x VDDQ, When VDD and VDDQ are less than 500mV; VREFCA may be equal to or less than 300mV
- 4) VPP must be equal or greater than VDD/VDDQ at all times.
- 5) Overshoot area above 1.5 V is specified in 10.3.4, 10.3.5 and 10.3.6.

9. AC & DC OPERATING CONDITIONS

[Table 6] Recommended DC Operating Conditions

| Symbol | Parameter | Rating | | | Unit | NOTE |
|--------|---------------------------|--------|------|------|------|-------|
| | | Min. | Typ. | Max. | | |
| VDD | Supply Voltage | 1.14 | 1.2 | 1.26 | V | 1,2,3 |
| VDDQ | Supply Voltage for Output | 1.14 | 1.2 | 1.26 | V | 1,2,3 |
| VPP | Peak-to-Peak Voltage | 2.375 | 2.5 | 2.75 | V | 3 |

NOTE :

- 1) Under all conditions V_{DDQ} must be less than or equal to V_{DD}.
- 2) V_{DDQ} tracks with V_{DD}. AC parameters are measured with V_{DD} and V_{DDQ} tied together.
- 3) DC bandwidth is limited to 20MHz.

10. AC & DC INPUT MEASUREMENT LEVELS

10.1 AC & DC Logic Input Levels for Single-Ended Signals

[Table 7] Single-ended AC & DC Input Levels for Command and Address

| Symbol | Parameter | DDR4-1600/1866/2133/2400 | | DDR4-2666 | | Unit | NOTE |
|---------------|---------------------------------------|--------------------------|---------------------|---------------------|---------------------|------|------|
| | | Min. | Max. | Min. | Max. | | |
| VIH.CA(DC75) | DC input logic high | $V_{REFCA} + 0.075$ | VDD | - | - | V | |
| VIH.CA(DC65) | | - | - | $V_{REFCA} + 0.065$ | VDD | | |
| VIL.CA(DC75) | DC input logic low | VSS | $V_{REFCA} - 0.075$ | - | - | V | |
| VIL.CA(DC65) | | - | - | VSS | $V_{REFCA} - 0.065$ | | |
| VIH.CA(AC100) | AC input logic high | $V_{REF} + 0.1$ | Note 2 | - | - | V | 1 |
| VIH.CA(AC90) | | - | - | $V_{REF} + 0.09$ | Note 2 | | |
| VIL.CA(AC100) | AC input logic low | Note 2 | $V_{REF} - 0.1$ | - | - | V | 1 |
| VIL.CA(AC90) | | - | - | Note 2 | $V_{REF} - 0.09$ | | |
| VREFCA(DC) | Reference Voltage for ADD, CMD inputs | $0.49 \cdot VDD$ | $0.51 \cdot VDD$ | $0.49 \cdot VDD$ | $0.51 \cdot VDD$ | V | 2,3 |

NOTE :

- 1) See "Overshoot and Undershoot Specifications" on section 10.3.
- 2) The AC peak noise on VREFCA may not allow VREFCA to deviate from VREFCA(DC) by more than $\pm 1\%$ VDD (for reference : approx. $\pm 12mV$)
- 3) For reference : approx. $VDD/2 \pm 12mV$.

10.2 AC and DC Input Measurement Levels: V_{REF} Tolerances.

The DC-tolerance limits and ac-noise limits for the reference voltages V_{REFCA} is illustrated in Figure 1. It shows a valid reference voltage $V_{REF}(t)$ as a function of time. (V_{REF} stands for V_{REFCA}).

$V_{REF}(DC)$ is the linear average of $V_{REF}(t)$ over a very long period of time (e.g. 1 sec). This average has to meet the min/max requirement in Table 7. Furthermore $V_{REF}(t)$ may temporarily deviate from $V_{REF}(DC)$ by no more than $\pm 1\%$ V_{DD} .

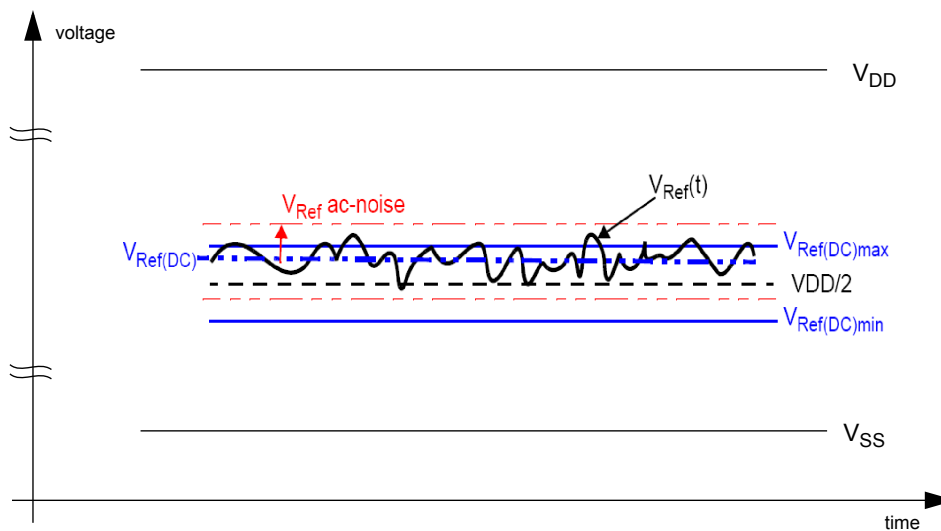

Figure 1. Illustration of $V_{REF}(DC)$ tolerance and V_{REF} AC-noise limits

The voltage levels for setup and hold time measurements $V_{IH}(AC)$, $V_{IH}(DC)$, $V_{IL}(AC)$ and $V_{IL}(DC)$ are dependent on V_{REF} .

" V_{REF} " shall be understood as $V_{REF}(DC)$, as defined in Figure 1.

This clarifies, that DC-variations of V_{REF} affect the absolute voltage a signal has to reach to achieve a valid high or low level and therefore the time to which setup and hold is measured. System timing and voltage budgets need to account for $V_{REF}(DC)$ deviations from the optimum position within the data-eye of the input signals.

This also clarifies that the DRAM setup/hold specification and derating values need to include time and voltage associated with V_{REF} AC-noise. Timing and voltage effects due to AC-noise on V_{REF} up to the specified limit ($\pm 1\%$ of V_{DD}) are included in DRAM timings and their associated deratings.

10.3 AC and DC Logic Input Levels for Differential Signals

10.3.1 Differential Signals Definition

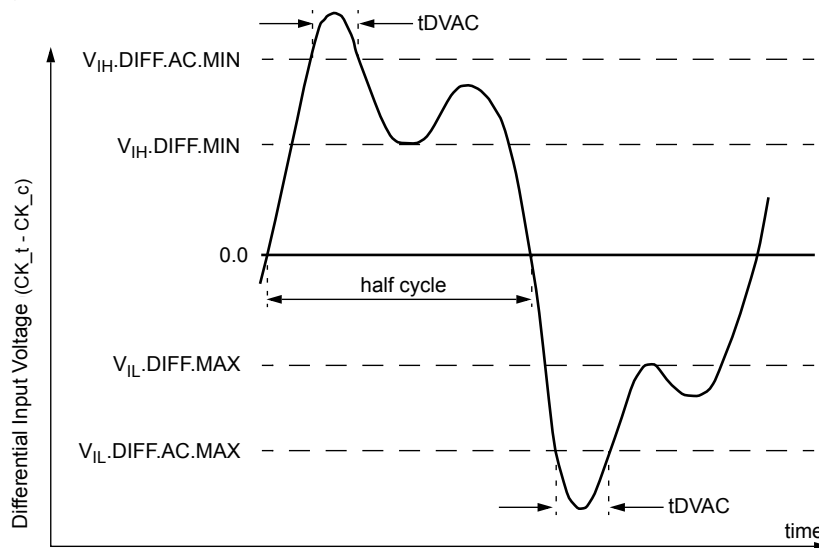

Figure 2. Definition of differential ac-swing and “time above ac-level” tDVAC

NOTE:

- 1) Differential signal rising edge from V_{IL.DIFF.MAX} to V_{IH.DIFF.MIN} must be monotonic slope.
- 2) Differential signal falling edge from V_{IH.DIFF.MIN} to V_{IL.DIFF.MAX} must be monotonic slope.

10.3.2 Differential Swing Requirements for Clock (CK_t - CK_c)

[Table 8] Differential AC and DC Input Levels

| Symbol | Parameter | DDR4 -1600/1866/2133 | | DDR4 -2400/2666 | | unit | NOTE |
|-------------------------|----------------------------|---|---|---|---|------|------|
| | | min | max | min | max | | |
| V _{IHdiff} | differential input high | +0.150 | NOTE 3 | 0.135 | NOTE 3 | V | 1 |
| V _{ILdiff} | differential input low | NOTE 3 | -0.150 | NOTE 3 | -0.135 | V | 1 |
| V _{IHdiff(AC)} | differential input high ac | 2 x (V _{IH(AC)} - V _{REF}) | NOTE 3 | 2 x (V _{IH(AC)} - V _{REF}) | NOTE 3 | V | 2 |
| V _{ILdiff(AC)} | differential input low ac | NOTE 3 | 2 x (V _{IL(AC)} - V _{REF}) | NOTE 3 | 2 x (V _{IL(AC)} - V _{REF}) | V | 2 |

NOTE :

- 1) Used to define a differential signal slew-rate.
- 2) for CK_t - CK_c use V_{IH,CA}/V_{IL,CA(AC)} of ADD/CMD and V_{REFCA};
- 3) These values are not defined; however, the differential signals CK_t - CK_c, need to be within the respective limits (V_{IH,CA(DC)} max, V_{IL,CA(DC)}min) for single-ended signals as well as the limitations for overshoot and undershoot.

[Table 9] Allowed Time Before Ringback (tDVAC) for CK_t - CK_c

| Slew Rate [V/ns] | tDVAC [ps] @ V _{IH/Ldiff(AC)} = 200mV | |
|------------------|---|-----|
| | min | max |
| > 4.0 | 120 | - |
| 4.0 | 115 | - |
| 3.0 | 110 | - |
| 2.0 | 105 | - |
| 1.8 | 100 | - |
| 1.6 | 95 | - |
| 1.4 | 90 | - |
| 1.2 | 85 | - |
| 1.0 | 80 | - |
| < 1.0 | 80 | - |

10.3.3 Single-ended Requirements for Differential Signals

Each individual component of a differential signal (CK_t, CK_c) has also to comply with certain requirements for single-ended signals.

CK_t and CK_c have to approximately reach VSEHmin / VSELmax (approximately equal to the ac-levels (VIH.CA(AC) / VIL.CA(AC)) for ADD/CMD signals) in every half-cycle.

Note that the applicable ac-levels for ADD/CMD might be different per speed-bin etc. E.g., if Different value than VIH.CA(AC100)/VIL.CA(AC100) is used for ADD/CMD signals, then these ac-levels apply also for the single-ended signals CK_t and CK_c.

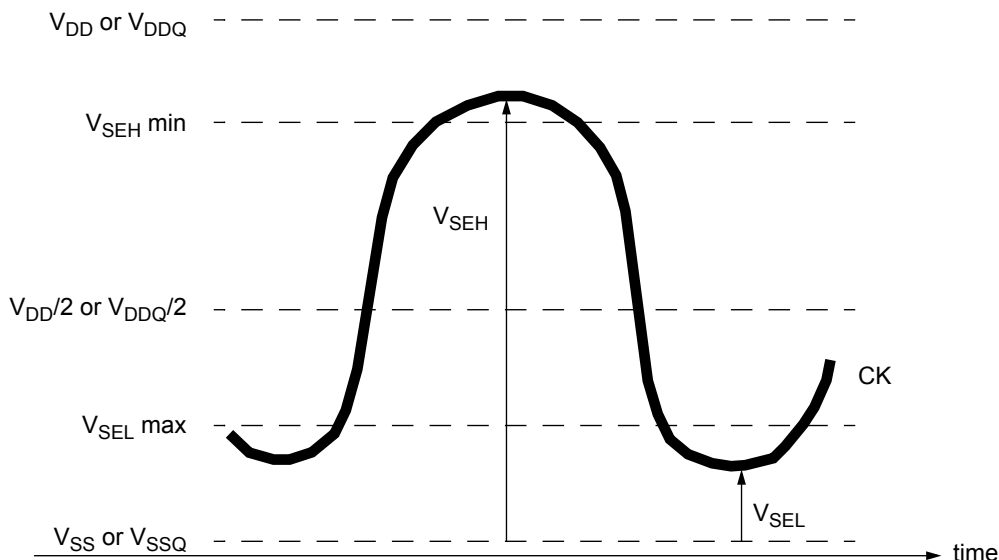

Figure 3. Single-ended requirement for differential signals.

Note that, while ADD/CMD signal requirements are with respect to VrefCA, the single-ended components of differential signals have a requirement with respect to VDD / 2; this is nominally the same. The transition of single-ended signals through the ac-levels is used to measure setup time. For single-ended components of differential signals the requirement to reach VSELmax, VSEHmin has no bearing on timing, but adds a restriction on the common mode characteristics of these signals.

[Table 10] Single-ended Levels for CK_t, CK_c

| Symbol | Parameter | DDR4-1600/1866/2133 | | DDR4-2400/2666 | | Unit | NOTE |
|------------------|--|---------------------|---------------|----------------|--------------|------|------|
| | | Min | Max | Min | Max | | |
| V _{SEH} | Single-ended high-level for CK_t, CK_c | (VDD/2)+0.100 | NOTE3 | (VDD/2)+0.95 | NOTE3 | V | 1, 2 |
| V _{SEL} | Single-ended low-level for CK_t, CK_c | NOTE3 | (VDD/2)-0.100 | NOTE3 | (VDD/2)-0.95 | V | 1, 2 |

- NOTE :
- 1) For CK_t - CK_c use V_{IH,CA}/V_{IL,CA}(AC) of ADD/CMD;
 - 2) V_{IH}(AC)/V_{IL}(AC) for ADD/CMD is based on V_{REFCA};
 - 3) These values are not defined, however the single-ended signals CK_t - CK_c need to be within the respective limits (V_{IH,CA}(DC) max, V_{IL,CA}(DC)min) for single-ended signals as well as the limitations for overshoot and undershoot.

10.3.4 Address, Command and Control Overshoot and Undershoot specifications

[Table 11] AC overshoot/undershoot specification for Address, Command and Control pins

| Parameter | Symbol | Specification | | | | | Unit | NOTE | |
|--|--------|---------------|-----------|-----------|-----------|-----------|------|------|---|
| | | DDR4-1600 | DDR4-1866 | DDR4-2133 | DDR4-2400 | DDR4-2666 | | | |
| Maximum peak amplitude above VAOS | VAOSP | 0.06 | | | | | TBD | V | |
| Upper boundary of overshoot area AAOS1 | VAOS | VDD +0.24 | | | | | TBD | V | 1 |
| Maximum peak amplitude allowed for undershoot | VAUS | 0.30 | | | | | TBD | V | |
| Maximum overshoot area per 1 tCK above VAOS | AAOS2 | 0.0083 | 0.0071 | 0.0062 | 0.0055 | TBD | V-ns | | |
| Maximum overshoot area per 1 tCK between VDD and VAOS | AAOS1 | 0.2550 | 0.2185 | 0.1914 | 0.1699 | TBD | V-ns | | |
| Maximum undershoot area per 1 tCK below VSS | AAUS | 0.2644 | 0.2265 | 0.1984 | 0.1762 | TBD | V-ns | | |
| (A0-A13,A17,BG0-BG1,BA0-BA1,ACT_n,RAS_n/A16,CAS_n/A15,WE_n/A14,CS_n,CKE,ODT,C2-C0) | | | | | | | | | |

NOTE :
 1) The value of VAOS matches VDD absolute max as defined in Table 5 Absolute Maximum DC Ratings if VDD equals VDD max as defined in Table 6 Recommended DC Operating Conditions. If VDD is above the recommended operating conditions, VAOS remains at VDD absolute max as defined in Table 5.

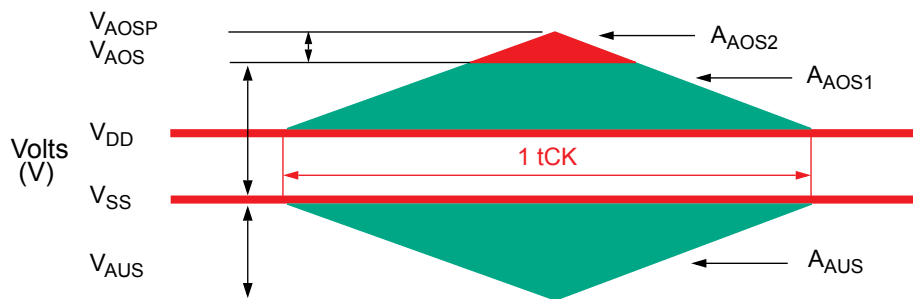

Figure 4. Address, Command and Control Overshoot and Undershoot Definition

10.3.5 Clock Overshoot and Undershoot Specifications

[Table 12] AC overshoot/undershoot specification for Clock

| Parameter | Symbol | Specification | | | | | Unit | NOTE | |
|--|--------|---------------|-----------|-----------|-----------|-----------|------|------|---|
| | | DDR4-1600 | DDR4-1866 | DDR4-2133 | DDR4-2400 | DDR4-2666 | | | |
| Maximum peak amplitude above VCOS | VCOSP | 0.06 | | | | | TBD | V | |
| Upper boundary of overshoot area ADOS1 | VCOS | VDD +0.24 | | | | | TBD | V | 1 |
| Maximum peak amplitude allowed for undershoot | VCUS | 0.30 | | | | | TBD | V | |
| Maximum overshoot area per 1 UI above VCOS | ACOS2 | 0.0038 | 0.0032 | 0.0028 | 0.0025 | TBD | V-ns | | |
| Maximum overshoot area per 1 UI between VDD and VDOS | ACOS1 | 0.1125 | 0.0964 | 0.0844 | 0.0750 | TBD | V-ns | | |
| Maximum undershoot area per 1 UI below VSS | ACUS | 0.1144 | 0.0980 | 0.0858 | 0.0762 | TBD | V-ns | | |
| (CK_t, CK_c) | | | | | | | | | |

NOTE :
 1) The value of VCOS matches VDD absolute max as defined in Table 5 Absolute Maximum DC Ratings if VDD equals VDD max as defined in Table 6 Recommended DC Operating Conditions. If VDD is above the recommended operating conditions, VCOS remains at VDD absolute max as defined in Table 5.

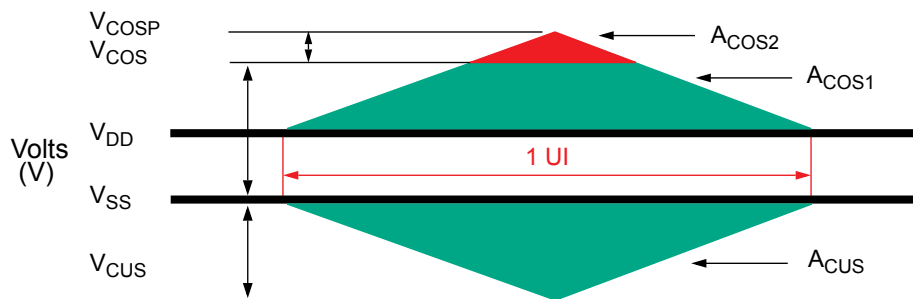

Figure 5. Clock Overshoot and Undershoot Definition

10.3.6 Data, Strobe and Mask Overshoot and Undershoot Specifications

[Table 13] AC overshoot/undershoot specification for Data, Strobe and Mask

| Parameter | Symbol | Specification | | | | | Unit | NOTE | |
|---|--------|---------------|-----------|-----------|-----------|-----------|------|------|---|
| | | DDR4-1600 | DDR4-1866 | DDR4-2133 | DDR4-2400 | DDR4-2666 | | | |
| Maximum peak amplitude above VDOS | VDOSP | 0.16 | 0.16 | 0.16 | 0.16 | TBD | V | | |
| Upper boundary of overshoot area ADOS1 | VDOS | VDDQ + 0.24 | | | | | TBD | V | 1 |
| Lower boundary of undershoot area ADUS1 | VDUS | 0.30 | 0.30 | 0.30 | 0.30 | TBD | V | 2 | |
| Maximum peak amplitude below VDUS | VDUSP | 0.10 | 0.10 | 0.10 | 0.10 | TBD | V | | |
| Maximum overshoot area per 1 UI above VDOS | ADOS2 | 0.0150 | 0.0129 | 0.0113 | 0.0100 | TBD | V-ns | | |
| Maximum overshoot area per 1 UI between VDDQ and VDOS | ADOS1 | 0.1050 | 0.0900 | 0.0788 | 0.0700 | TBD | V-ns | | |
| Maximum undershoot area per 1 UI between VSSQ and VDUS1 | ADUS1 | 0.1050 | 0.0900 | 0.0788 | 0.0700 | TBD | V-ns | | |
| Maximum undershoot area per 1 UI below VDUS | ADUS2 | 0.0150 | 0.0129 | 0.0113 | 0.0100 | TBD | V-ns | | |

NOTE :
 1) The value of VDOS matches (VIN, VOUT) max as defined in Table 5 Absolute Maximum DC Ratings if VDDQ equals VDDQ max as defined in Table 6 Recommended DC Operating Conditions. If VDDQ is above the recommended operating conditions, VDOS remains at (VIN, VOUT) max as defined in Table 5.
 2) The value of VDUS matches (VIN, VOUT) min as defined in Table 5 Absolute Maximum DC Ratings

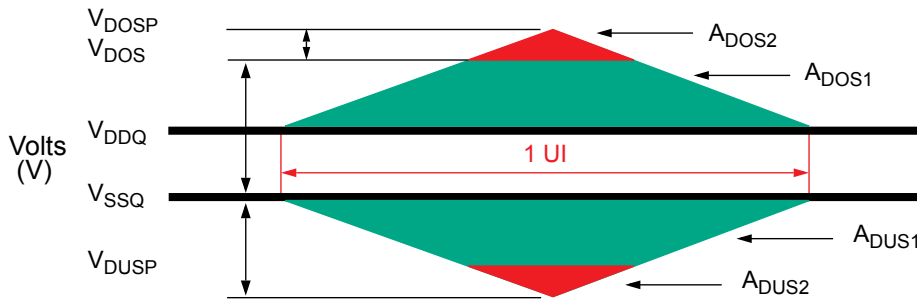

Figure 6. Data, Strobe and Mask Overshoot and Undershoot Definition

10.4 Slew Rate Definitions

10.4.1 Slew Rate Definitions for Differential Input Signals (CK)

Input slew rate for differential signals (CK_t, CK_c) are defined and measured as shown in Table 14 and Figure 7.

[Table 14] Differential Input Slew Rate Definition

| Description | Measured | | Defined by |
|--|------------------------|------------------------|--|
| | from | to | |
| Differential input slew rate for rising edge (CK _t - CK _c) | V _{ILdiffmax} | V _{IHdiffmin} | $[V_{IHdiffmin} - V_{ILdiffmax}] / \Delta TR_{diff}$ |
| Differential input slew rate for falling edge (CK _t - CK _c) | V _{IHdiffmin} | V _{ILdiffmax} | $[V_{IHdiffmin} - V_{ILdiffmax}] / \Delta TF_{diff}$ |

NOTE :

1) The differential signal (i.e., CK_t - CK_c) must be linear between these thresholds.

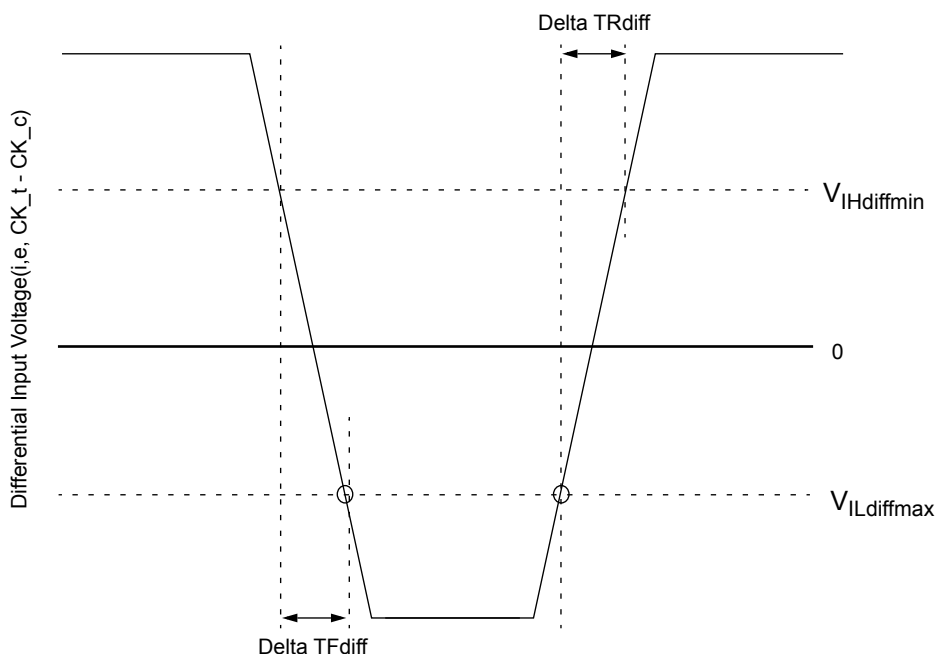

Figure 7. Differential Input Slew Rate Definition for CK_t, CK_c

10.4.2 Slew Rate Definition for Single-ended Input Signals (CMD/ADD)

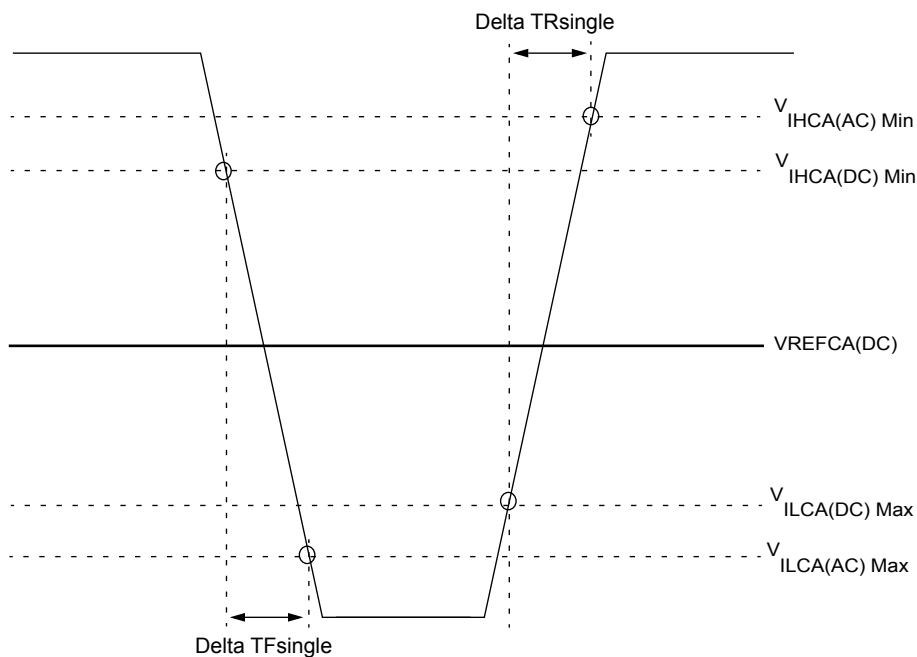

Figure 8. Single-ended Input Slew Rate definition for CMD and ADD

NOTE :

- 1) Single-ended input slew rate for rising edge = $\{V_{IHCA(AC)Min} - V_{ILCA(DC)Max}\} / \Delta T_{Rsingle}$.
- 2) Single-ended input slew rate for falling edge = $\{V_{IHCA(DC)Min} - V_{ILCA(AC)Max}\} / \Delta T_{Fsingle}$.
- 3) Single-ended signal rising edge from $V_{ILCA(DC)Max}$ to $V_{IHCA(DC)Min}$ must be monotonic slope.
- 4) Single-ended signal falling edge from $V_{IHCA(DC)Min}$ to $V_{ILCA(DC)Max}$ must be monotonic slope.

10.5 Differential Input Cross Point Voltage

To guarantee tight setup and hold times as well as output skew parameters with respect to clock, each cross point voltage of differential input signals (CK_t, CK_c) must meet the requirements in Table 15. The differential input cross point voltage VIX is measured from the actual cross point of true and complement signals to the midlevel between of VDD and VSS.

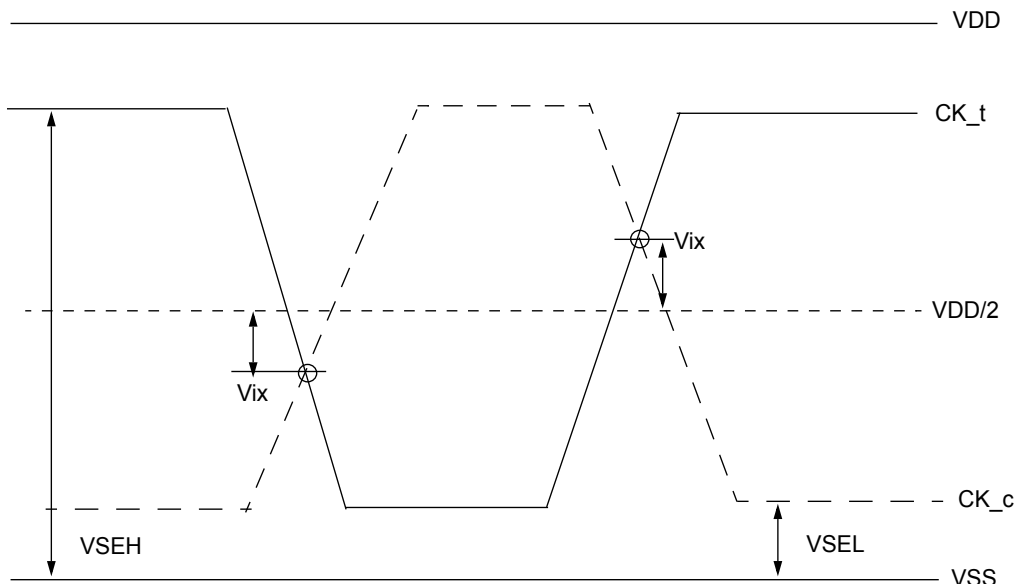

Figure 9. Vix Definition (CK)

[Table 15] Cross Point Voltage for Differential Input Signals (CK)

| Symbol | Parameter | DDR4-1600/1866/2133 | | | |
|---------|--|------------------------|--|--|------------------------|
| | | min | | max | |
| - | Area of VSEH, VSEL | $VSEL < VDD/2 - 145mV$ | $VDD/2 - 145mV \leq VSEL \leq VDD/2 - 100mV$ | $VDD/2 + 100mV \leq VSEH \leq VDD/2 + 145mV$ | $VDD/2 + 145mV < VSEH$ |
| VIX(CK) | Differential Input Cross Point Voltage relative to VDD/2 for CK _t , CK _c | -120mV | $-(VDD/2 - VSEL) + 25mV$ | $(VSEH - VDD/2) - 25mV$ | 120mV |

| Symbol | Parameter | DDR4-2400 | | | |
|---------|--|-------------------------|--|--|-------------------------|
| | | min | | max | |
| - | Area of VSEH, VSEL | $VSEL < VDD/2 - 145 mV$ | $VDD/2 - 145 mV \leq VSEL \leq VDD/2 - 100 mV$ | $VDD/2 + 100 mV \leq VSEH \leq VDD/2 + 145 mV$ | $VDD/2 + 145 mV < VSEH$ |
| VIX(CK) | Differential Input Cross Point Voltage relative to VDD/2 for CK _t , CK _c | -120mV | $-(VDD/2 - VSEL) + 25 mV$ | $(VSEH - VDD/2) - 25 mV$ | 120mV |

| Symbol | Parameter | DDR4-2666 | | | |
|---------|--|-------------------------|--|--|-------------------------|
| | | min | | max | |
| - | Area of VSEH, VSEL | $VSEL < VDD/2 - 145 mV$ | $VDD/2 - 145 mV \leq VSEL \leq VDD/2 - 100 mV$ | $VDD/2 + 100 mV \leq VSEH \leq VDD/2 + 145 mV$ | $VDD/2 + 145 mV < VSEH$ |
| VIX(CK) | Differential Input Cross Point Voltage relative to VDD/2 for CK _t , CK _c | -110 mV | $-(VDD/2 - VSEL) + 30 mV$ | $(VSEH - VDD/2) - 30 mV$ | 110mV |

10.6 CMOS rail to rail Input Levels

10.6.1 CMOS rail to rail Input Levels for RESET_n

[Table 16] CMOS rail to rail Input Levels for RESET_n

| Parameter | Symbol | Min | Max | Unit | NOTE |
|-----------------------|---------------|---------|---------|------|------|
| AC Input High Voltage | VIH(AC)_RESET | 0.8*VDD | VDD | V | 6 |
| DC Input High Voltage | VIH(DC)_RESET | 0.7*VDD | VDD | V | 2 |
| DC Input Low Voltage | VIL(DC)_RESET | VSS | 0.3*VDD | V | 1 |
| AC Input Low Voltage | VIL(AC)_RESET | VSS | 0.2*VDD | V | 7 |
| Rising time | TR_RESET | - | 1.0 | us | 4 |
| RESET pulse width | tPW_RESET | 1.0 | - | us | 3,5 |

- NOTE :**
- 1) After RESET_n is registered LOW, RESET_n level shall be maintained below VIL(DC)_RESET during tPW_RESET, otherwise, SDRAM may not be reset.
 - 2) Once RESET_n is registered HIGH, RESET_n level must be maintained above VIH(DC)_RESET, otherwise, SDRAM operation will not be guaranteed until it is reset asserting RESET_n signal LOW.
 - 3) RESET is destructive to data contents.
 - 4) No slope reversal(ringback) requirement during its level transition from Low to High.
 - 5) This definition is applied only "Reset Procedure at Power Stable".
 - 6) Overshoot might occur. It should be limited by the Absolute Maximum DC Ratings.
 - 7) Undershoot might occur. It should be limited by Absolute Maximum DC Ratings.

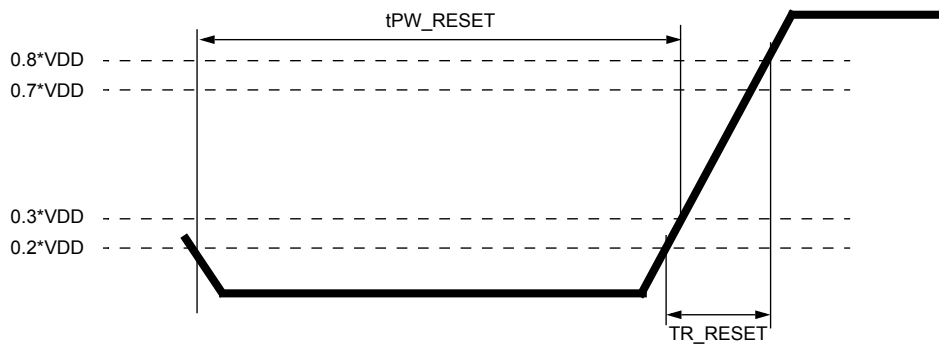

Figure 10. RESET_n Input Slew Rate Definition

10.7 AC and DC Logic Input Levels for DQS Signals

10.7.1 Differential signal definition

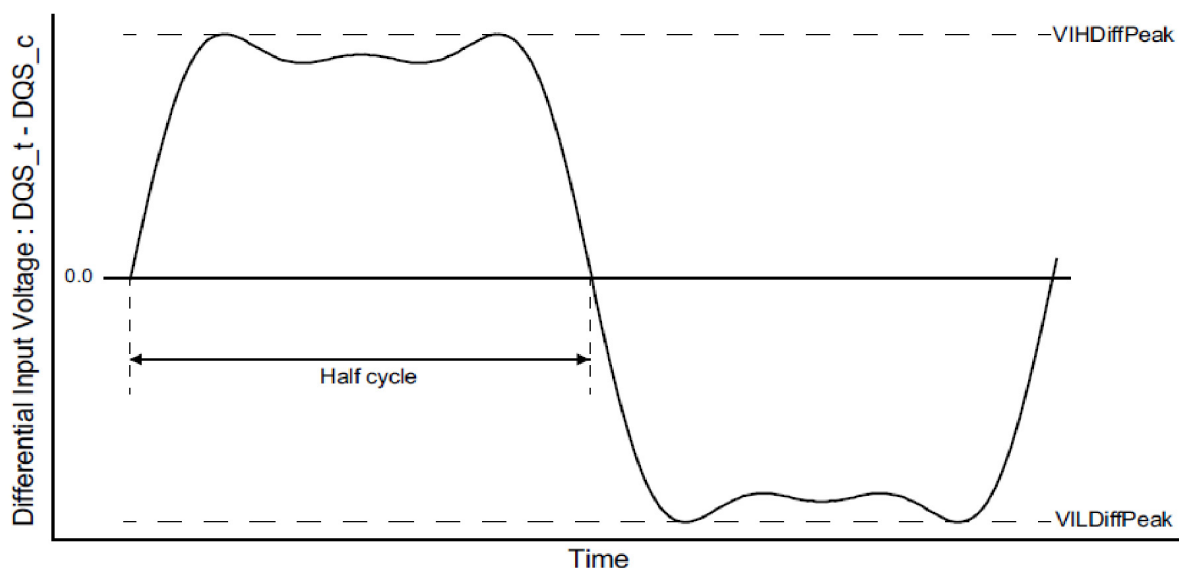

Figure 11. Definition of differential DQS Signal AC-swing Level

10.7.2 Differential swing requirements for DQS (DQS_t - DQS_c)

[Table 17] Differential AC and DC Input Levels for DQS

| Symbol | Parameter | DDR4-1600, 1866, 2133 | | DDR4-2400 | | DDR4-2666 | | Unit | Note |
|-------------|-----------------------|-----------------------|-------|-----------|-------|-----------|-------|------|------|
| | | Min | Max | Min | Max | Min | Max | | |
| VIHDiffPeak | VIH.DIFF.Peak Voltage | 186 | Note2 | 160 | Note2 | 150 | Note2 | mV | 1 |
| VILDiffPeak | VIL.DIFF.Peak Voltage | Note2 | -186 | Note2 | -160 | Note2 | -150 | mV | 1 |

- NOTE :
- 1) Used to define a differential signal slew-rate.
 - 2) These values are not defined; however, the differential signals DQS_t - DQS_c, need to be within the respective limits Overshoot, Undershoot Specification for single-ended signals.

10.7.3 Peak voltage calculation method

The peak voltage of Differential DQS signals are calculated in a following equation.

$$VIH.DIFF.Peak\ Voltage = \text{Max}(f(t))$$

$$VIL.DIFF.Peak\ Voltage = \text{Min}(f(t))$$

$$f(t) = VDQS_t - VDQS_c$$

The $\text{Max}(f(t))$ or $\text{Min}(f(t))$ used to determine the midpoint which to reference the $\pm 35\%$ window of the exempt non-monotonic signaling shall be the smallest peak voltage observed in all ui's.

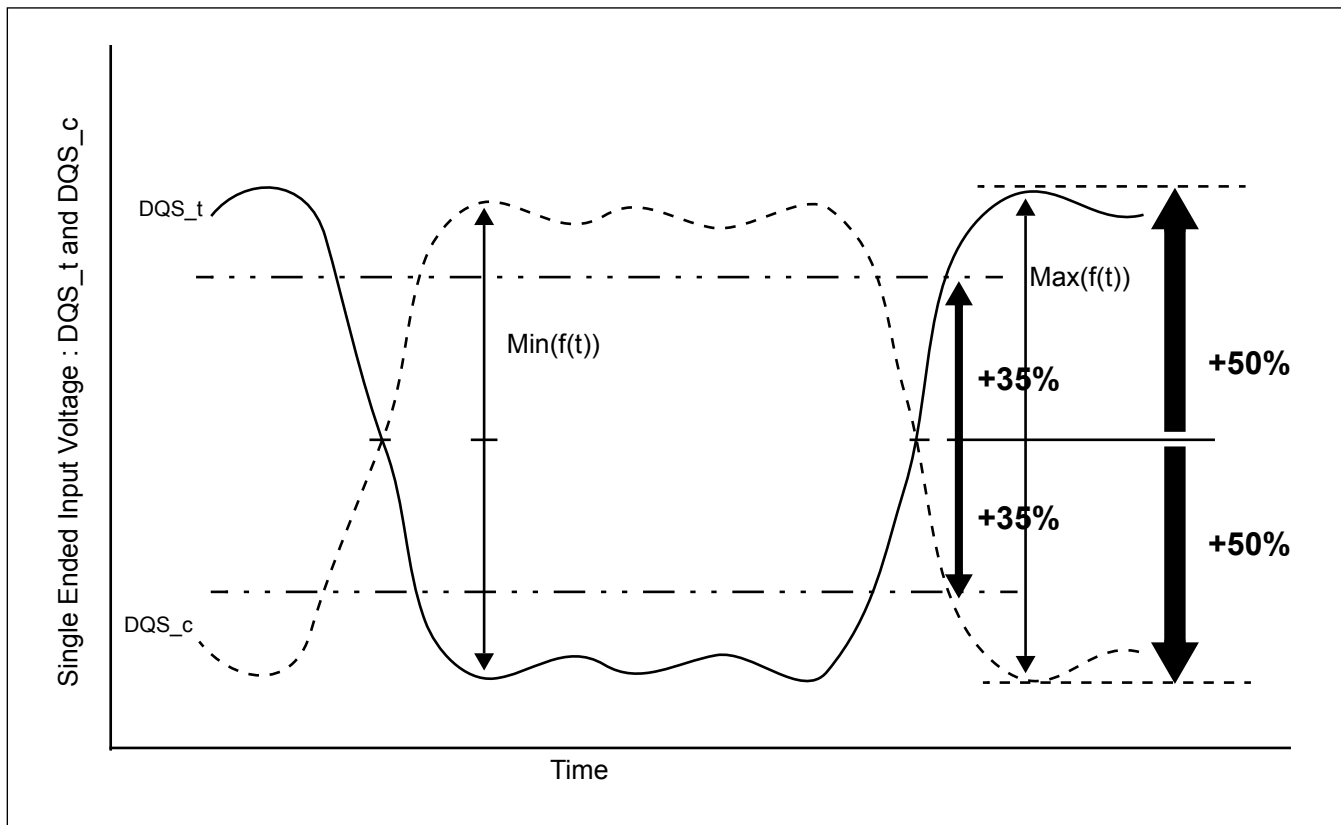

Figure 12. Definition of differential DQS Peak Voltage and rage of exempt non-monotonic signaling

10.7.4 Differential Input Cross Point Voltage

To achieve tight RxMask input requirements as well as output skew parameters with respect to strobe, the cross point voltage of differential input signals (DQS_t, DQS_c) must meet the requirements in Table 18. The differential input cross point voltage VIX_{DQS} (VIX_{DQS_FR} and VIX_{DQS_RF}) is measured from the actual cross point of DQS_t, DQS_c relative to the VDQSmid of the DQS_t and DQS_c signals.

VDQSmid is the midpoint of the minimum levels achieved by the transitioning DQS_t and DQS_c signals, and noted by VDQSmid. VDQSmid is the difference between the lowest horizontal tangent above VDQSmid of the transitioning DQS signals and the highest horizontal tangent below VDQSmid of the transitioning DQS signals.

A non-monotonic transitioning signal's ledge is exempt or not used in determination of a horizontal tangent provided the said ledge occurs within +/- 35% of the midpoint of either VIH.DIFF.Peak Voltage (DQS_t rising) or VIL.DIFF.Peak Voltage (DQS_c rising), refer to Figure 12. A secondary horizontal tangent resulting from a ring-back transition is also exempt in determination of a horizontal tangent. That is, a falling transition's horizontal tangent is derived from its negative slope to zero slope transition (point A in Figure 13) and a ring-back's horizontal tangent derived from its positive slope to zero slope transition (point B in Figure 13) is not a valid horizontal tangent; and a rising transition's horizontal tangent is derived from its positive slope to zero slope transition (point C in Figure 13) and a ring-back's horizontal tangent derived from its negative slope to zero slope transition (point D in Figure 13) is not a valid horizontal tangent.

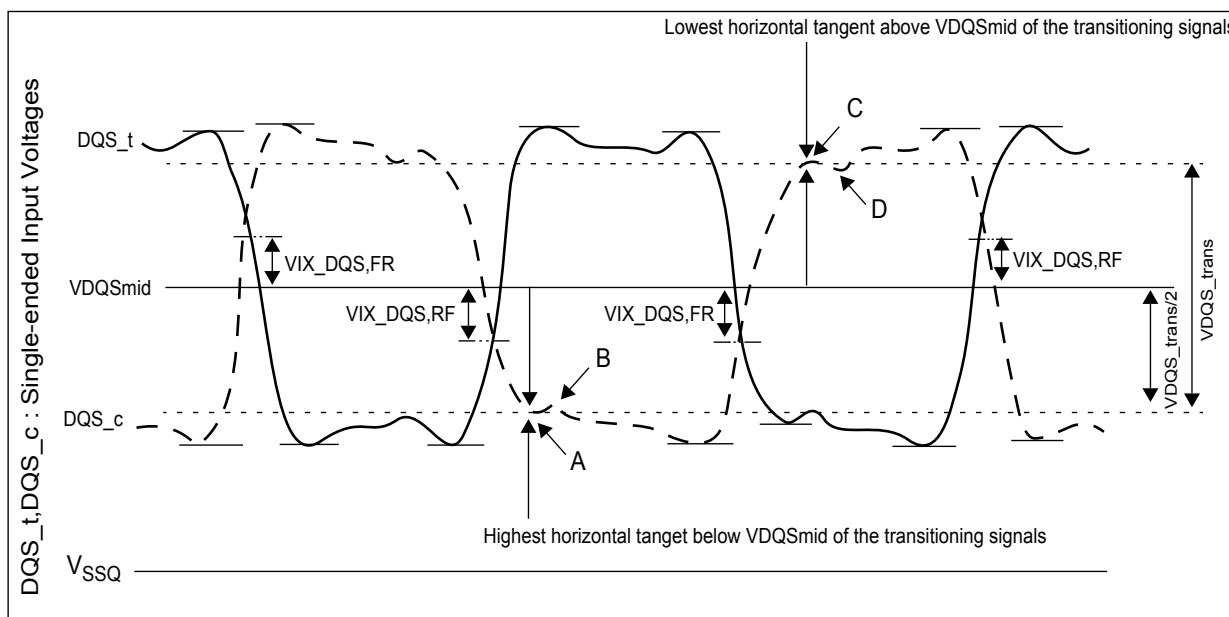

Figure 13. Vix Definition (DQS)

[Table 18] Cross point voltage for DQS differential input signals

| Symbol | Parameter | DDR4-1600/1866/2133/ | | DDR4-2666 | | Unit | Note |
|------------------|--|----------------------|------------------|-----------|------------------|------|---------|
| | | Min | Max | Min | Max | | |
| Vix_DQS_ratio | DQS _t and DQS _c crossing relative to the midpoint of the DQS _t and DQS _c signal swings | - | 25 | - | 25 | % | 1, 2 |
| VDQSmid_to_Vcent | VDQSmid offset relative to Vcent_DQ(midpoint) | - | min (VIHdiff,50) | - | min (VIHdiff,50) | mV | 3, 4, 5 |

- NOTE :**
- 1) Vix_DQS_Ratio is DQS VIX crossing (Vix_DQS_FR or Vix_DQS_RF) divided by VDQSmid. VDQSmid is the difference between the lowest horizontal tangent above VDQSmid of the transitioning DQS signals and the highest horizontal tangent below VDQSmid of the transitioning DQS signals.
 - 2) VDQSmid will be similar to the VREFDQ internal setting value obtained during Vref Training if the DQS and DQs drivers and paths are matched.
 - 3) The maximum limit shall not exceed the smaller of VIHdiff minimum limit or 50mV.
 - 4) VIX measurements are only applicable for transitioning DQS_t and DQS_c signals when toggling data, preamble and high-z states are not applicable conditions.
 - 5) The parameter VDQSmid is defined for simulation and ATE testing purposes, it is not expected to be tested in a system.

10.7.5 Differential Input Slew Rate Definition

Input slew rate for differential signals (DQS_t, DQS_c) are defined and measured as shown in Figure 13 and Figure 14.

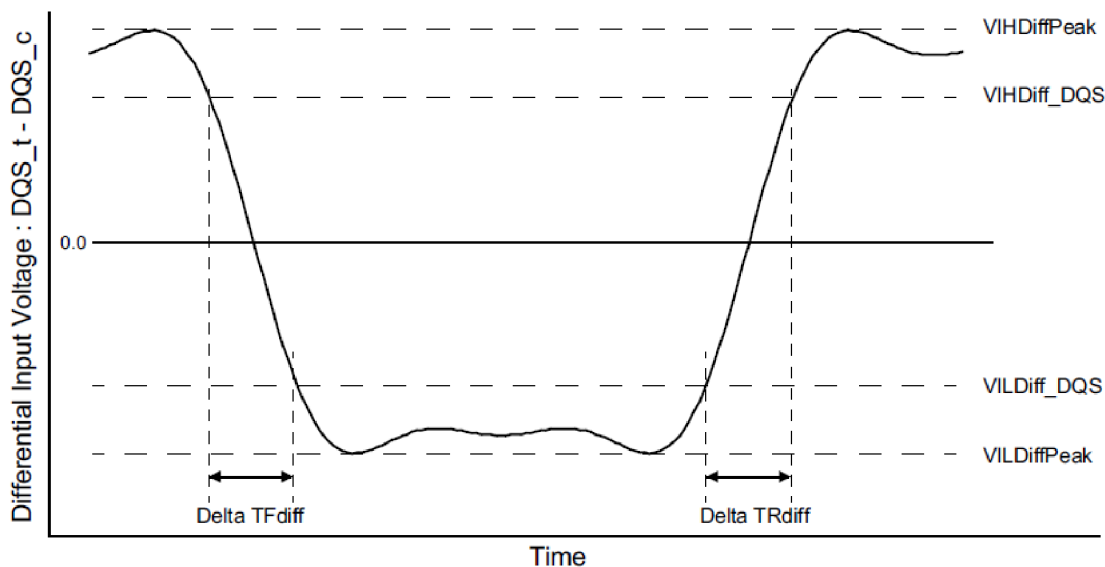

Figure 14. Differential Input Slew Rate Definition for DQS_t, DQS_c

- NOTE :
- 1) Differential signal rising edge from VILDiff_DQS to VIHDiff_DQS must be monotonic slope.
 - 2) Differential signal falling edge from VIHDiff_DQS to VILDiff_DQS must be monotonic slope.

[Table 19] Differential Input Slew Rate Definition for DQS_t, DQS_c

| Description | Measured | | Defined by |
|--|-------------|-------------|---|
| | From | To | |
| Differential input slew rate for rising edge (DQS _t - DQS _c) | VILDiff_DQS | VIHDiff_DQS | $ VILDiff_DQS - VIHDiff_DQS / \Delta TRdiff$ |
| Differential input slew rate for falling edge (DQS _t - DQS _c) | VIHDiff_DQS | VILDiff_DQS | $ VILDiff_DQS - VIHDiff_DQS / \Delta TFdiff$ |

[Table 20] Differential Input Level for DQS_t, DQS_c

| Symbol | Parameter | DDR4-1600/1866/2133 | | DDR4-2400/2666 | | Unit | NOTE |
|-------------|-------------------------|---------------------|------|----------------|------|------|------|
| | | Min | Max | Min | Max | | |
| VIHDiff_DQS | Differential Input High | 136 | - | 130 | - | mV | |
| VILDiff_DQS | Differential Input Low | - | -136 | - | -130 | mV | |

[Table 21] Differential Input Slew Rate for DQS_t, DQS_c

| Symbol | Parameter | DDR4-1600/1866/2133/2400 | | DDR4-2666 | | Unit | NOTE |
|---------|------------------------------|--------------------------|-----|-----------|-----|------|------|
| | | Min | Max | Min | Max | | |
| SRIdiff | Differential Input Slew Rate | 3 | 18 | 2.5 | 18 | V/ns | |

11. AC AND DC OUTPUT MEASUREMENT LEVELS

11.1 Output Driver DC Electrical Characteristics

The DDR4 driver supports two different Ron values. These Ron values are referred as strong(low Ron) and weak mode(high Ron). A functional representation of the output buffer is shown in the figure below. Output driver impedance RON is defined as follows:

The individual pull-up and pull-down resistors (RON_{Pu} and RON_{Pd}) are defined as follows:

$$RON_{Pu} = \frac{VDDQ - V_{out}}{|I_{out}|} \quad \text{under the condition that } RON_{Pd} \text{ is off}$$

$$RON_{Pd} = \frac{V_{out}}{|I_{out}|} \quad \text{under the condition that } RON_{Pu} \text{ is off}$$

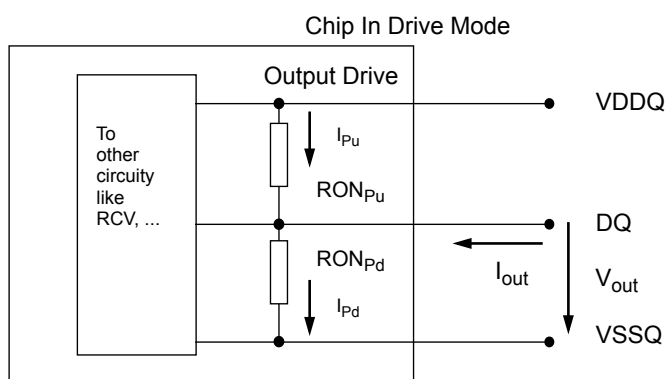

Figure 15. Output driver

[Table 22] Output Driver DC Electrical Characteristics, assuming RZQ=240ohm; entire operating temperature range; after proper ZQ calibration

| RON _{NOM} | Resistor | Vout | Min | Nom | Max | Unit | NOTE |
|--|----------|------------------|------|-----|------|-------|---------|
| 34Ω | RON34Pd | VOLdc= 0.5*VDDQ | 0.73 | 1 | 1.1 | RZQ/7 | 1,2 |
| | | VOMdc= 0.8* VDDQ | 0.83 | 1 | 1.1 | RZQ/7 | 1,2 |
| | | VOHdc= 1.1* VDDQ | 0.83 | 1 | 1.25 | RZQ/7 | 1,2 |
| | RON34Pu | VOLdc= 0.5* VDDQ | 0.9 | 1 | 1.25 | RZQ/7 | 1,2 |
| | | VOMdc= 0.8* VDDQ | 0.9 | 1 | 1.1 | RZQ/7 | 1,2 |
| | | VOHdc= 1.1* VDDQ | 0.8 | 1 | 1.1 | RZQ/7 | 1,2 |
| 48Ω | RON48Pd | VOLdc= 0.5*VDDQ | 0.73 | 1 | 1.1 | RZQ/5 | 1,2 |
| | | VOMdc= 0.8* VDDQ | 0.83 | 1 | 1.1 | RZQ/5 | 1,2 |
| | | VOHdc= 1.1* VDDQ | 0.83 | 1 | 1.25 | RZQ/5 | 1,2 |
| | RON48Pu | VOLdc= 0.5* VDDQ | 0.9 | 1 | 1.25 | RZQ/5 | 1,2 |
| | | VOMdc= 0.8* VDDQ | 0.9 | 1 | 1.1 | RZQ/5 | 1,2 |
| | | VOHdc= 1.1* VDDQ | 0.8 | 1 | 1.1 | RZQ/5 | 1,2 |
| Mismatch between pull-up and pull-down, MMPuPd | | VOMdc= 0.8* VDDQ | -10 | - | 17 | % | 1,2,3,4 |
| Mismatch DQ-DQ within byte variation pull-up, MMPudd | | VOMdc= 0.8* VDDQ | - | - | 10 | % | 1,2,4 |
| Mismatch DQ-DQ within byte variation pull-dn, MMPddd | | VOMdc= 0.8* VDDQ | - | - | 10 | % | 1,2,4 |

NOTE :

- 1) The tolerance limits are specified after calibration with stable voltage and temperature. For the behavior of the tolerance limits if temperature or voltage changes after calibration, see following section on voltage and temperature sensitivity (TBD).
- 2) Pull-up and pull-dn output driver impedances are recommended to be calibrated at 0.8 * VDDQ. Other calibration schemes may be used to achieve the linearity spec shown above, e.g. calibration at 0.5 * VDDQ and 1.1 * VDDQ.
- 3) Measurement definition for mismatch between pull-up and pull-down, MMPuPd : Measure RONPu and RONPD both at 0.8*VDD separately; Ronnom is the nominal Ron value

$$MMPuPd = \frac{RONPu - RONPd}{RONNOM} * 100$$

- 4) RON variance range ratio to RON Nominal value in a given component, including DQS_t and DQS_c.

$$MMPudd = \frac{RONPuMax - RONPuMin}{RONNOM} * 100$$

$$MMPddd = \frac{RONPdMax - RONPdMin}{RONNOM} * 100$$

- 5) This parameter of x16 device is specified for Uper byte and Lower byte.

11.1.1 Alert_n output Drive Characteristic

A functional representation of the output buffer is shown in the figure below. Output driver impedance RON is defined as follows:

$$RON_{Pd} = \frac{V_{out}}{|I_{out}|} \text{ under the condition that } RON_{Pu} \text{ is off}$$

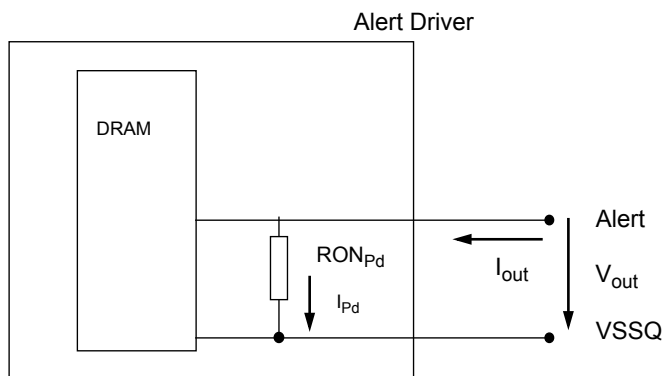

| Resistor | Vout | Min | Max | Unit | NOTE |
|-------------------|--------------------------------|-----|-----|------|------|
| RON _{Pd} | V _{OLdc} = 0.1 * VDDQ | 0.3 | 1.2 | 34Ω | 1 |
| | V _{OMdc} = 0.8 * VDDQ | 0.4 | 1.2 | 34Ω | 1 |
| | V _{OHdc} = 1.1 * VDDQ | 0.4 | 1.4 | 34Ω | 1 |

NOTE:
 1) VDDQ voltage is at VDDQ DC. VDDQ DC definition is TBD.

11.1.2 Output Driver Characteristic of Connectivity Test (CT) Mode

Following Output driver impedance RON will be applied Test Output Pin during Connectivity Test (CT) Mode. The individual pull-up and pull-down resistors (RONPu_CT and RONPd_CT) are defined as follows:

$$RON_{Pu_CT} = \frac{V_{DDQ} - V_{OUT}}{|I_{out}|}$$

$$RON_{Pd_CT} = \frac{V_{OUT}}{|I_{out}|}$$

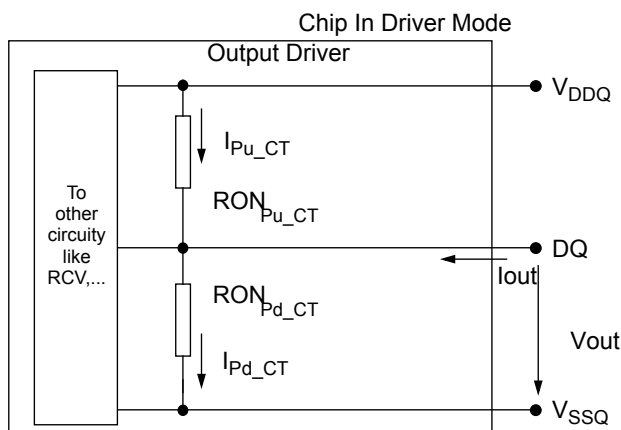

Figure 16. Output Driver

| RON _{NOM_CT} | Resistor | Vout | Max | Units | NOTE |
|-----------------------|----------------------|--|-----|-------|------|
| 34Ω | RON _{Pd_CT} | VOB _{dc} = 0.2 x V _{DDQ} | 1.9 | 34Ω | 1 |
| | | VOL _{dc} = 0.5 x V _{DDQ} | 2.0 | 34Ω | 1 |
| | | VOM _{dc} = 0.8 x V _{DDQ} | 2.2 | 34Ω | 1 |
| | | VOH _{dc} = 1.1 x V _{DDQ} | 2.5 | 34Ω | 1 |
| | RON _{Pu_CT} | VOB _{dc} = 0.2 x V _{DDQ} | 2.5 | 34Ω | 1 |
| | | VOL _{dc} = 0.5 x V _{DDQ} | 2.2 | 34Ω | 1 |
| | | VOM _{dc} = 0.8 x V _{DDQ} | 2.0 | 34Ω | 1 |
| | | VOH _{dc} = 1.1 x V _{DDQ} | 1.9 | 34Ω | 1 |

NOTE :

1) Connectivity test mode uses un-calibrated drivers, showing the full range over PVT. No mismatch between pull up and pull down is defined.

11.2 Single-ended AC & DC Output Levels

[Table 23] Single-ended AC & DC Output Levels

| Symbol | Parameter | DDR4-1600/1866/2133/2400/2666 | Units | NOTE |
|--------------|---|-------------------------------|-------|------|
| $V_{OH}(DC)$ | DC output high measurement level (for IV curve linearity) | $1.1 \times V_{DDQ}$ | V | |
| $V_{OM}(DC)$ | DC output mid measurement level (for IV curve linearity) | $0.8 \times V_{DDQ}$ | V | |
| $V_{OL}(DC)$ | DC output low measurement level (for IV curve linearity) | $0.5 \times V_{DDQ}$ | V | |
| $V_{OH}(AC)$ | AC output high measurement level (for output SR) | $(0.7 + 0.15) \times V_{DDQ}$ | V | 1 |
| $V_{OL}(AC)$ | AC output low measurement level (for output SR) | $(0.7 - 0.15) \times V_{DDQ}$ | V | 1 |

NOTE :

1) The swing of $\pm 0.15 \times V_{DDQ}$ is based on approximately 50% of the static single-ended output peak-to-peak swing with a driver impedance of $RZQ/7\Omega$ and an effective test load of 50Ω to $V_{TT} = V_{DDQ}$.

11.3 Differential AC & DC Output Levels

[Table 24] Differential AC & DC Output Levels

| Symbol | Parameter | DDR4-1600/1866/2133/2400/2666 | Units | NOTE |
|------------------|---|-------------------------------|-------|------|
| $V_{OHdiff}(AC)$ | AC differential output high measurement level (for output SR) | $+0.3 \times V_{DDQ}$ | V | 1 |
| $V_{OLdiff}(AC)$ | AC differential output low measurement level (for output SR) | $-0.3 \times V_{DDQ}$ | V | 1 |

NOTE :

1) The swing of $\pm 0.3 \times V_{DDQ}$ is based on approximately 50% of the static differential output peak-to-peak swing with a driver impedance of $RZQ/7\Omega$ and an effective test load of 50Ω to $V_{TT} = V_{DDQ}$ at each of the differential outputs.

11.4 Single-ended Output Slew Rate

With the reference load for timing measurements, output slew rate for falling and rising edges is defined and measured between $V_{OL(AC)}$ and $V_{OH(AC)}$ for single ended signals as shown in Table 25 and Figure 17.

[Table 25] Single-ended Output Slew Rate Definition

| Description | Measured | | Defined by |
|--|--------------|--------------|--|
| | From | To | |
| Single ended output slew rate for rising edge | $V_{OL(AC)}$ | $V_{OH(AC)}$ | $[V_{OH(AC)} - V_{OL(AC)}] / \Delta TR_{se}$ |
| Single ended output slew rate for falling edge | $V_{OH(AC)}$ | $V_{OL(AC)}$ | $[V_{OH(AC)} - V_{OL(AC)}] / \Delta TF_{se}$ |

NOTE :
 1) Output slew rate is verified by design and characterization, and may not be subject to production test.

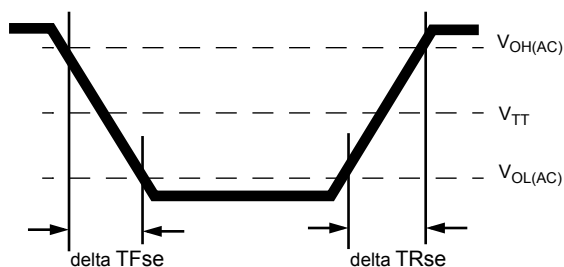

Figure 17. Single-ended Output Slew Rate Definition

[Table 26] Single-ended Output Slew Rate

| Parameter | Symbol | DDR4-1600 | | DDR4-1866 | | DDR4-2133 | | DDR4-2400 | | DDR4-2666 | | Units |
|-------------------------------|--------|-----------|-----|-----------|-----|-----------|-----|-----------|-----|-----------|-----|-------|
| | | Min | Max | Min | Max | Min | Max | Min | Max | Min | Max | |
| Single ended output slew rate | SRQse | 4 | 9 | 4 | 9 | 4 | 9 | 4 | 9 | 4 | 9 | V/ns |

Description: SR: Slew Rate
 Q: Query Output (like in DQ, which stands for Data-in, Query-Output)
 se: Single-ended Signals
 For Ron = RZQ/7 setting

NOTE :
 1. In two cases, a maximum slew rate of 12 V/ns applies for a single DQ signal within a byte lane.
 -Case 1 is defined for a single DQ signal within a byte lane which is switching into a certain direction (either from high to low or low to high) while all remaining DQ signals in the same byte lane are static (i.e. they stay at either high or low).
 -Case 2 is defined for a single DQ signal within a byte lane which is switching into a certain direction (either from high to low or low to high) while all remaining DQ signals in the same byte lane are switching into the opposite direction (i.e. from low to high or high to low respectively). For the remaining DQ signal switching into the opposite direction, the regular maximum limit of 9 V/ns applies

11.5 Differential Output Slew Rate

With the reference load for timing measurements, output slew rate for falling and rising edges is defined and measured between VOLdiff(AC) and VOHdiff(AC) for differential signals as shown in Table 27 and Figure 18.

[Table 27] Differential Output Slew Rate Definition

| Description | Measured | | Defined by |
|--|-------------|-------------|--|
| | From | To | |
| Differential output slew rate for rising edge | VOLdiff(AC) | VOHdiff(AC) | $[V_{OHdiff}(AC) - V_{OLdiff}(AC)] / \Delta TR_{diff}$ |
| Differential output slew rate for falling edge | VOHdiff(AC) | VOLdiff(AC) | $[V_{OHdiff}(AC) - V_{OLdiff}(AC)] / \Delta TF_{diff}$ |

NOTE:
 1) Output slew rate is verified by design and characterization, and may not be subject to production test.

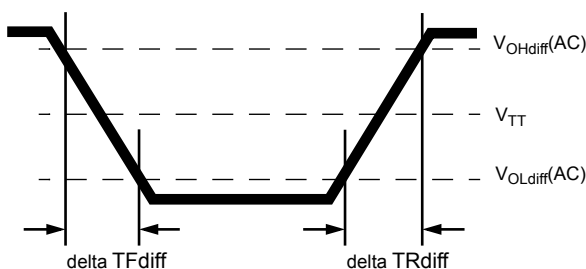

Figure 18. Differential Output Slew Rate Definition

[Table 28] Differential Output Slew Rate

| Parameter | Symbol | DDR4-1600 | | DDR4-1866 | | DDR4-2133 | | DDR4-2400 | | DDR4-2666 | | Units |
|-------------------------------|---------|-----------|-----|-----------|-----|-----------|-----|-----------|-----|-----------|-----|-------|
| | | Min | Max | Min | Max | Min | Max | Min | Max | Min | Max | |
| Differential output slew rate | SRQdiff | 8 | 18 | 8 | 18 | 8 | 18 | 8 | 18 | 8 | 18 | V/ns |

Description:
 SR: Slew Rate
 Q: Query Output (like in DQ, which stands for Data-in, Query-Output)
 diff: Differential Signals
 For Ron = RZQ/7 setting

11.6 Single-ended AC & DC Output Levels of Connectivity Test Mode

Following output parameters will be applied for DDR4 SDRAM Output Signal during Connectivity Test Mode.

[Table 29] Single-ended AC & DC Output Levels of Connectivity Test Mode

| Symbol | Parameter | DDR4-1600/1866/2133/2400/2666 | Unit | Notes |
|--------------|--|---------------------------------|------|-------|
| $V_{OH(DC)}$ | DC output high measurement level (for IV curve linearity) | 1.1 x VDDQ | V | |
| $V_{OM(DC)}$ | DC output mid measurement level (for IV curve linearity) | 0.8 x VDDQ | V | |
| $V_{OL(DC)}$ | DC output low measurement level (for IV curve linearity) | 0.5 x VDDQ | V | |
| $V_{OB(DC)}$ | DC output below measurement level (for IV curve linearity) | 0.2 x VDDQ | V | |
| $V_{OH(AC)}$ | AC output high measurement level (for output SR) | $V_{TT} + (0.1 \times V_{DDQ})$ | V | 1 |
| $V_{OL(AC)}$ | AC output below measurement level (for output SR) | $V_{TT} - (0.1 \times V_{DDQ})$ | V | 1 |

NOTE :

1) The effective test load is 50Ω terminated by $V_{TT} = 0.5 * V_{DDQ}$.

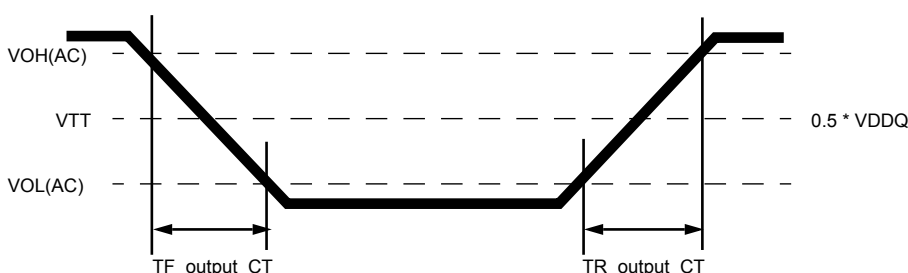

Figure 19. Output Slew Rate Definition of Connectivity Test Mode

[Table 30] Single-ended Output Slew Rate of Connectivity Test Mode

| Parameter | Symbol | DDR4-1600/1866/2133/2400/2666 | | Unit | Notes |
|----------------------------|--------------|-------------------------------|-----|------|-------|
| | | Min | Max | | |
| Output signal Falling time | TF_output_CT | - | 10 | ns/V | |
| Output signal Rising time | TR_output_CT | - | 10 | ns/V | |

11.7 Test Load for Connectivity Test Mode Timing

The reference load for ODT timings is defined in Figure 20.

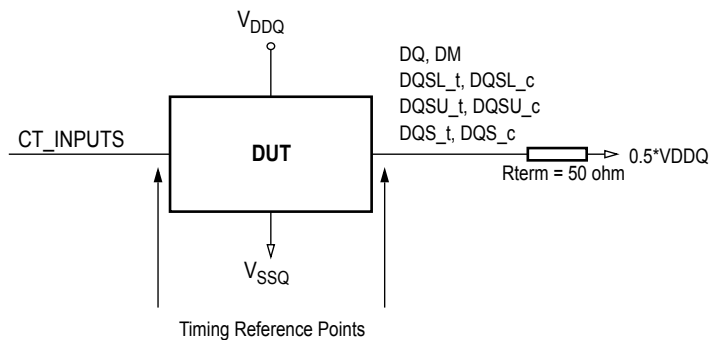

Figure 20. Connectivity Test Mode Timing Reference Load

12. SPEED BIN

[Table 31] DDR4-1600 Speed Bins and Operations

| Speed Bin | | | DDR4-1600 | | Unit | NOTE | |
|---|---------|-------------------------------------|---|-------------------------------------|------|-------|---------------|
| CL-nRCD-nRP | | | 11-11-11 | | | | |
| Parameter | Symbol | | min | max | | | |
| Internal read command to first data | tAA | | 13.75 ¹³⁾ (13.50) ^{5),10)} | 18.00 | ns | 11 | |
| Internal read command to first data with read DBI enabled | tAA_DBI | | tAA(min) + 2nCK | tAA(max) + 2nCK | ns | 11 | |
| ACT to internal read or write delay time | tRCD | | 13.75 (13.50) ^{5),10)} | - | ns | 11 | |
| PRE command period | tRP | | 13.75 (13.50) ^{5),10)} | - | ns | 11 | |
| ACT to PRE command period | tRAS | | 35 | 9 x tREFI | ns | 11 | |
| ACT to ACT or REF command period | tRC | | 48.75 (48.50) ^{5),10)} | - | ns | 11 | |
| | Normal | Read DBI | | | | | |
| CWL = 9 | CL = 9 | CL = 11 (Optional) ⁵⁾ | tCK(AVG) | 1.5 (Optional) ^{5),10)} | 1.6 | ns | 1,2,3,4,10,13 |
| | CL = 10 | CL = 12 | tCK(AVG) | Reserved | | ns | 1,2,3,4,10 |
| CWL = 9,11 | CL = 10 | CL = 12 | tCK(AVG) | Reserved | | ns | 1,2,3,4 |
| | CL = 11 | CL = 13 | tCK(AVG) | 1.25 | <1.5 | ns | 1,2,3,4 |
| | CL = 12 | CL = 14 | tCK(AVG) | 1.25 | <1.5 | ns | 1,2,3 |
| Supported CL Settings | | | (9),11,12 | | nCK | 12,13 | |
| Supported CL Settings with read DBI | | | (11),13,14 | | nCK | 12 | |
| Supported CWL Settings | | | 9,11 | | nCK | | |

[Table 32] DDR4-1866 Speed Bins and Operations

| Speed Bin | | | DDR4-1866 | | Unit | NOTE | |
|---|---------|-------------------------------------|---|------------------------------|-------|---------|---------------|
| CL-nRCD-nRP | | | 13-13-13 | | | | |
| Parameter | Symbol | | min | max | | | |
| Internal read command to first data | tAA | | 13.92 ¹³⁾ (13.50) ^{5),11)} | 18.00 | ns | 11 | |
| Internal read command to first data with read DBI enabled | tAA_DBI | | tAA(min) + 2nCK | tAA(max) + 2nCK | ns | 11 | |
| ACT to internal read or write delay time | tRCD | | 13.92 (13.50) ^{5),11)} | - | ns | 11 | |
| PRE command period | tRP | | 13.92 (13.50) ^{5),11)} | - | ns | 11 | |
| ACT to PRE command period | tRAS | | 34 | 9 x tREFI | ns | 11 | |
| ACT to ACT or REF command period | tRC | | 47.92 (47.50) ^{5),11)} | - | ns | 11 | |
| | Normal | Read DBI | | | | | |
| CWL = 9 | CL = 9 | CL = 11 (Optional) ⁵⁾ | tCK(AVG) | 1.5 | 1.6 | ns | 1,2,3,4,10,13 |
| | | | | (Optional) ^{5),11)} | | | |
| | CL = 10 | CL = 12 | tCK(AVG) | Reserved | | ns | 1,2,3,4,10 |
| CWL = 9,11 | CL = 10 | CL = 12 | tCK(AVG) | Reserved | | ns | 4 |
| | CL = 11 | CL = 13 | tCK(AVG) | 1.25 | <1.5 | ns | 1,2,3,4,6 |
| | | | | (Optional) ^{5),11)} | | | |
| CL = 12 | CL = 14 | tCK(AVG) | 1.25 | <1.5 | ns | 1,2,3,6 | |
| CWL = 10,12 | CL = 12 | CL = 14 | tCK(AVG) | Reserved | | ns | 1,2,3,4 |
| | CL = 13 | CL = 15 | tCK(AVG) | 1.071 | <1.25 | ns | 1,2,3,4 |
| | CL = 14 | CL = 16 | tCK(AVG) | 1.071 | <1.25 | ns | 1,2,3 |
| Supported CL Settings | | | 9,11,12,13,14 | | nCK | 12,13 | |
| Supported CL Settings with read DBI | | | 11,13,14,15,16 | | nCK | 12 | |
| Supported CWL Settings | | | 9,10,11,12 | | nCK | | |

[Table 33] DDR4-2133 Speed Bins and Operations

| Speed Bin | | | DDR4-2133 | | Unit | NOTE | |
|---|---------|-------------------------------------|---|---------------------------------------|--------|-------|---------------|
| CL-nRCD-nRP | | | 15-15-15 | | | | |
| Parameter | | Symbol | min | max | | | |
| Internal read command to first data | | tAA | 14.06 ¹³⁾ (13.50) ^{5),11)} | 18.00 | ns | 11 | |
| Internal read command to first data with read DBI enabled | | tAA_DBI | tAA(min) + 3nCK | tAA(max) + 3nCK | ns | 11 | |
| ACT to internal read or write delay time | | tRCD | 14.06 (13.50) ^{5),11)} | - | ns | 11 | |
| PRE command period | | tRP | 14.06 (13.50) ^{5),11)} | - | ns | 11 | |
| ACT to PRE command period | | tRAS | 33 | 9 x tREFI | ns | 11 | |
| ACT to ACT or REF command period | | tRC | 47.06 (46.50) ^{5),11)} | - | ns | 11 | |
| | Normal | Read DBI | | | | | |
| CWL = 9 | CL = 9 | CL = 11 (Optional) ⁵⁾ | tCK(AVG) | 1.5 (Optional) ^{5),11)} | 1.6 | ns | 1,2,3,4,10,13 |
| | CL = 10 | CL = 12 | tCK(AVG) | Reserved | | ns | 1,2,3,10 |
| CWL = 9,11 | CL = 11 | CL = 13 | tCK(AVG) | 1.25 (Optional) ^{5),11)} | <1.5 | ns | 1,2,3,4,7 |
| | CL = 12 | CL = 14 | tCK(AVG) | 1.25 | <1.5 | ns | 1,2,3,7 |
| CWL = 10,12 | CL = 13 | CL = 15 | tCK(AVG) | 1.071 (Optional) ^{5),11)} | <1.25 | ns | 1,2,3,4,7 |
| | CL = 14 | CL = 16 | tCK(AVG) | 1.071 | <1.25 | ns | 1,2,3,7 |
| CWL = 11,14 | CL = 14 | CL = 17 | tCK(AVG) | Reserved | | ns | 1,2,3,4 |
| | CL = 15 | CL = 18 | tCK(AVG) | 0.937 | <1.071 | ns | 1,2,3,4 |
| | CL = 16 | CL = 19 | tCK(AVG) | 0.937 | <1.071 | ns | 1,2,3 |
| Supported CL Settings | | | (9),(11), 12,(13),14,15,16 | | nCK | 12,13 | |
| Supported CL Settings with read DBI | | | (11),(13),14,(15),16,18,19 | | nCK | | |
| Supported CWL Settings | | | 9,10,11,12,14 | | nCK | | |

[Table 34] DDR4-2400 Speed Bins and Operations

| Speed Bin | | | DDR4-2400 | | Unit | NOTE | |
|---|---------|-------------------------------------|------------------------------------|------------------------------|--------|---------|------------|
| CL-nRCD-nRP | | | 17-17-17 | | | | |
| Parameter | Symbol | | min | max | | | |
| Internal read command to first data | tAA | | 14.16 (13.75) ^{5),11)} | 18.00 | ns | 11 | |
| Internal read command to first data with read DBI enabled | tAA_DBI | | tAA(min) + 3nCK | tAA(max) + 3nCK | ns | 11 | |
| ACT to internal read or write delay time | tRCD | | 14.16 (13.75) ^{5),11)} | - | ns | 11 | |
| PRE command period | tRP | | 14.16 (13.75) ^{5),11)} | - | ns | 11 | |
| ACT to PRE command period | tRAS | | 32 | 9 x tREFI | ns | 11 | |
| ACT to ACT or REF command period | tRC | | 46.16 (45.75) ^{5),11)} | - | ns | 11 | |
| | Normal | Read DBI | | | | | |
| CWL = 9 | CL = 9 | CL = 11 (Optional) ⁵⁾ | tCK(AVG) | Reserved | | ns | 1,2,3,4,10 |
| | CL = 10 | CL = 12 | tCK(AVG) | 1.5 | 1.6 | ns | 1,2,3,4,10 |
| CWL = 9,11 | CL = 10 | CL = 12 | tCK(AVG) | Reserved | | ns | 4 |
| | CL = 11 | CL = 13 | tCK(AVG) | 1.25 | <1.5 | ns | 1,2,3,4,8 |
| | | | | (Optional) ^{5),11)} | | | |
| CL = 12 | CL = 14 | tCK(AVG) | 1.25 | <1.5 | ns | 1,2,3,8 | |
| CWL = 10,12 | CL = 12 | CL = 14 | tCK(AVG) | Reserved | | ns | 4 |
| | CL = 13 | CL = 15 | tCK(AVG) | 1.071 | <1.25 | ns | 1,2,3,4,8 |
| | | | | (Optional) ^{5),11)} | | | |
| CL = 14 | CL = 16 | tCK(AVG) | 1.071 | <1.25 | ns | 1,2,3,8 | |
| CWL = 11,14 | CL = 14 | CL = 17 | tCK(AVG) | Reserved | | ns | 4 |
| | CL = 15 | CL = 18 | tCK(AVG) | 0.937 | <1.071 | ns | 1,2,3,4,8 |
| | | | | (Optional) ^{5),11)} | | | |
| CL = 16 | CL = 19 | tCK(AVG) | 0.937 | <1.071 | ns | 1,2,3,8 | |
| CWL = 12,16 | CL = 15 | CL = 18 | tCK(AVG) | Reserved | | ns | 1,2,3,4 |
| | CL = 16 | CL = 19 | tCK(AVG) | Reserved | | ns | 1,2,3,4 |
| | CL = 17 | CL = 20 | tCK(AVG) | 0.833 | <0.937 | ns | |
| | CL = 18 | CL = 21 | tCK(AVG) | 0.833 | <0.937 | ns | 1,2,3 |
| Supported CL Settings | | | 10,11,12,13,14,15,16,17,18 | | nCK | 12 | |
| Supported CL Settings with read DBI | | | 12,13,14,15,16,18,19,20,21 | | nCK | | |
| Supported CWL Settings | | | 9,10,11,12,14,16 | | nCK | | |

[Table 35] DDR4-2666 Speed Bins and Operations

| Speed Bin | | | DDR4-2666 | | Unit | NOTE |
|---|---------|----------|---|---|------|------------|
| CL-nRCD-nRP | | | 19-19-19 | | | |
| Parameter | Symbol | | min | max | | |
| Internal read command to first data | tAA | | 14.25 ¹³⁾ (13.75) ^{5),11)} | 18.00 | ns | 11 |
| Internal read command to first data with read DBI enabled | tAA_DBI | | tAA(min) + 3nCK | tAA(max) + 3nCK | ns | 11 |
| ACT to internal read or write delay time | tRCD | | 14.25 (13.75) ^{5),11)} | - | ns | 11 |
| PRE command period | tRP | | 14.25 ¹³⁾ (13.75) ^{5),11)} | - | ns | 11 |
| ACT to PRE command period | tRAS | | 32 | 9 x tREFI | ns | 11 |
| ACT to ACT or REF command period | tRC | | 46.25 (45.75) ^{5),11)} | - | ns | 11 |
| | Normal | Read DBI | | | | |
| CWL = 9 | CL = 9 | CL = 11 | tCK(AVG) | Reserved | ns | 1,2,3,4,10 |
| | CL = 10 | CL = 12 | tCK(AVG) | 1.5 1.6 | ns | 1,2,3,10 |
| CWL = 9,11 | CL = 10 | CL = 12 | tCK(AVG) | Reserved | ns | 4 |
| | CL = 11 | CL = 13 | tCK(AVG) | 1.25 <1.5 (Optional) ^{5),11)} | ns | 1,2,3,4,9 |
| | CL = 12 | CL = 14 | tCK(AVG) | 1.25 <1.5 | ns | 1,2,3,9 |
| CWL = 10,12 | CL = 12 | CL = 14 | tCK(AVG) | Reserved | ns | 4 |
| | CL = 13 | CL = 15 | tCK(AVG) | 1.071 <1.25 (Optional) ^{5),11)} | ns | 1,2,3,4,9 |
| | CL = 14 | CL = 16 | tCK(AVG) | 1.071 <1.25 | ns | 1,2,3,9 |
| CWL = 11,14 | CL = 14 | CL = 17 | tCK(AVG) | Reserved | ns | 4 |
| | CL = 15 | CL = 18 | tCK(AVG) | 0.937 <1.071 (Optional) ^{5),11)} | ns | 1,2,3,4,9 |
| | CL = 16 | CL = 19 | tCK(AVG) | 0.937 <1.071 | ns | 1,2,3,9 |
| CWL = 12,16 | CL = 15 | CL = 18 | tCK(AVG) | Reserved | ns | 4 |
| | CL = 16 | CL = 19 | tCK(AVG) | Reserved | ns | 1,2,3,4,9 |
| | CL = 17 | CL = 20 | tCK(AVG) | 0.833 <0.937 (Optional) ^{5),11)} | ns | 1,2,3,4,9 |
| | CL = 18 | CL = 21 | tCK(AVG) | 0.833 <0.937 | ns | 1,2,3 |
| CWL = 14,18 | CL = 17 | CL = 20 | tCK(AVG) | Reserved | ns | 1,2,3,4 |
| | CL = 18 | CL = 21 | tCK(AVG) | Reserved | ns | 1,2,3,4 |
| | CL = 19 | CL = 22 | tCK(AVG) | 0.75 <0.833 | ns | 1,2,3,4 |
| | CL = 20 | CL = 23 | tCK(AVG) | 0.75 <0.833 | ns | 1,2,3 |
| Supported CL Settings | | | 10,(11),12,(13),14,(15),16,(17),18,19,20 | | nCK | 12 |
| Supported CL Settings with read DBI | | | 12,(13),14,(15),17,(18),19,(20),21,22,23 | | nCK | |
| Supported CWL Settings | | | 9,10,11,12,14,16,18 | | nCK | |

12.1 Speed Bin Table Note

Absolute Specification

- VDDQ = VDD = 1.20V +/- 0.06 V
- VPP = 2.5V +0.25/-0.125 V
- The values defined with above-mentioned table are DLL ON case.
- DDR4-1600, 1866, 2133, 2400 and 2666 Speed Bin Tables are valid only when Geardown Mode is disabled.

- 1) The CL setting and CWL setting result in tCK(avg).MIN and tCK(avg).MAX requirements. When making a selection of tCK(avg), both need to be fulfilled: Requirements from CL setting as well as requirements from CWL setting.
- 2) tCK(avg).MIN limits: Since CAS Latency is not purely analog - data and strobe output are synchronized by the DLL - all possible intermediate frequencies may not be guaranteed. CL in clock cycle is calculated from tAA following rounding algorithm defined in Section 13.5.
- 3) tCK(avg).MAX limits: Calculate $tCK(avg) = tAA.MAX / CL\ SELECTED$ and round the resulting tCK(avg) down to the next valid speed bin (i.e. 1.5ns or 1.25ns or 1.071ns or 0.937ns or 0.833ns). This result is tCK(avg).MAX corresponding to CL SELECTED.
- 4) 'Reserved' settings are not allowed. User must program a different value.
- 5) 'Optional' settings allow certain devices in the industry to support this setting, however, it is not a mandatory feature. Refer to supplier's data sheet and/or the DIMM SPD information if and how this setting is supported.
- 6) Any DDR4-1866 speed bin also supports functional operation at lower frequencies as shown in the table which are not subject to Production Tests but verified by Design/Characterization.
- 7) Any DDR4-2133 speed bin also supports functional operation at lower frequencies as shown in the table which are not subject to Production Tests but verified by Design/Characterization.
- 8) Any DDR4-2400 speed bin also supports functional operation at lower frequencies as shown in the table which are not subject to Production Tests but verified by Design/Characterization.
- 9) Any DDR4-2666 speed bin also supports functional operation at lower frequencies as shown in the table which are not subject to Production Tests but verified by Design/Characterization.
- 10) DDR4-1600 AC timing apply if DRAM operates at lower than 1600 MT/s data rate.
- 11) Parameters apply from tCK(avg) min to tCK(avg) max at all standard JEDEC clock period values as stated in the Speed Bin Tables.
- 12) CL number in parentheses, it means that these numbers are optional.
- 13) DDR4 SDRAM supports CL=9 as long as a system meets tAA(min).
- 14) Each speed bin lists the timing requirements that need to be supported in order for a given DRAM to be JEDEC compliant. JEDEC compliance does not require support for all speed bins within a given speed. JEDEC compliance requires meeting the parameters for a least one of the listed speed bins.

13. IDD AND IDDQ SPECIFICATION PARAMETERS AND TEST CONDITIONS

13.1 IDD, IPP and IDDQ Measurement Conditions

In this chapter, IDD, IPP and IDDQ measurement conditions such as test load and patterns are defined. Figure 21 shows the setup and test load for IDD, IPP and IDDQ measurements.

- IDD currents (such as IDD0, IDD0A, IDD1, IDD1A, IDD2N, IDD2NA, IDD2NL, IDD2NT, IDD2P, IDD2Q, IDD3N, IDD3NA, IDD3P, IDD4R, IDD4RA, IDD4W, IDD4WA, IDD5B, IDD5F2, IDD5F4, IDD6N, IDD6E, IDD6R, IDD6A, IDD7 and IDD8) are measured as time-averaged currents with all VDD balls of the DDR4 SDRAM under test tied together. Any IPP or IDDQ current is not included in IDD currents.
 - IPP currents have the same definition as IDD except that the current on the VPP supply is measured.
 - IDDQ currents (such as IDDQ2NT and IDDQ4R) are measured as time-averaged currents with all VDDQ balls of the DDR4 SDRAM under test tied together. Any IDD current is not included in IDDQ currents.
- Attention: IDDQ values cannot be directly used to calculate IO power of the DDR4 SDRAM. They can be used to support correlation of simulated IO power to actual IO power as outlined in Figure 22. In DRAM module application, IDDQ cannot be measured separately since VDD and VDDQ are using one merged-power layer in Module PCB.

For IDD, IPP and IDDQ measurements, the following definitions apply:

- “0” and “LOW” is defined as $V_{IN} \leq V_{ILAC(max)}$.
- “1” and “HIGH” is defined as $V_{IN} \geq V_{IHAC(min)}$.
- “MID-LEVEL” is defined as inputs are $V_{REF} = V_{DD} / 2$.
- Timings used for IDD, IPP and IDDQ Measurement-Loop Patterns are provided in Table 36.
- Basic IDD, IPP and IDDQ Measurement Conditions are described in Table 38.
- Detailed IDD, IPP and IDDQ Measurement-Loop Patterns are described in Table 39 through Table 46.
- IDD Measurements are done after properly initializing the DDR4 SDRAM. This includes but is not limited to setting
 - RON = RZQ/7 (34 Ohm in MR1);
 - RTT_NOM = RZQ/6 (40 Ohm in MR1);
 - RTT_WR = RZQ/2 (120 Ohm in MR2);
 - RTT_PARK = Disable;
 - Qoff = 0_B (Output Buffer enabled) in MR1;
 - TDQS_t disabled in MR1;
 - CRC disabled in MR2;
 - CA parity feature disabled in MR5;
 - Gear down mode disabled in MR3
 - Read/Write DBI disabled in MR5;
 - DM disabled in MR5
- Attention: The IDD, IPP and IDDQ Measurement-Loop Patterns need to be executed at least one time before actual IDD or IDDQ measurement is started.
- Define D = {CS_n, ACT_n, RAS_n, CAS_n, WE_n} := {HIGH, LOW, LOW, LOW, LOW} ; apply BG/BA changes when directed.
- Define D# = {CS_n, ACT_n, RAS_n, CAS_n, WE_n} := {HIGH, HIGH, HIGH, HIGH, HIGH} ; apply invert of BG/BA changes when directed above.

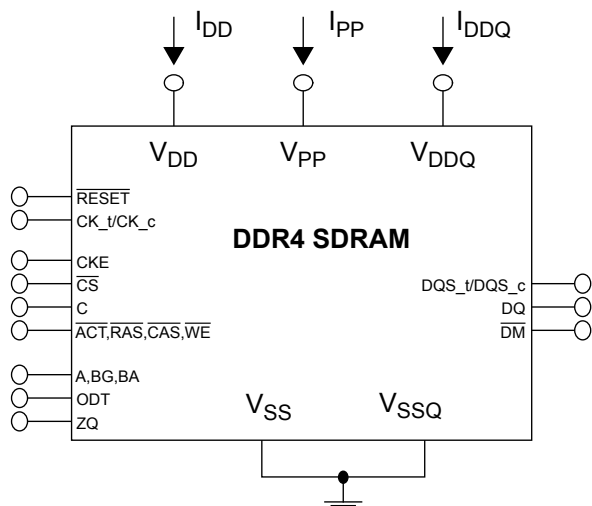

Figure 21. Measurement Setup and Test Load for IDD, IPP and IDDQ Measurements

NOTE :
 1) DIMM level Output test load condition may be different from above.

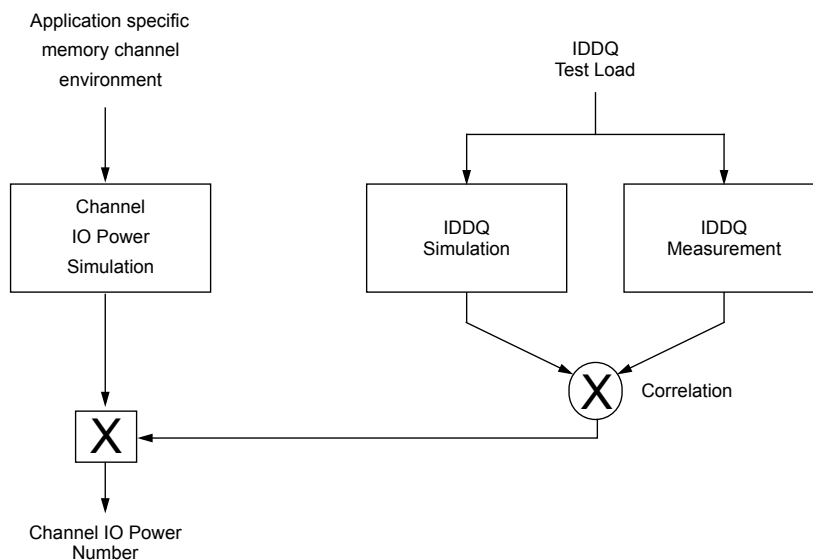

Figure 22. Correlation from simulated Channel IO Power to actual Channel IO Power supported by IDDQ Measurement.

[Table 36] Timings used for IDD, IPP and IDDQ Measurement-Loop Patterns

| Symbol | | DDR4-1600 | DDR4-1866 | DDR4-2133 | DDR4-2400 | DDR4-2666 | Unit |
|-----------|----|-----------|-----------|-----------|-----------|-----------|------|
| | | 11-11-11 | 13-13-13 | 15-15-15 | 17-17-17 | 19-19-19 | |
| tCK | | 1.25 | 1.071 | 0.937 | 0.833 | 0.75 | ns |
| CL | | 11 | 13 | 15 | 17 | 19 | nCK |
| CWL | | 11 | 12 | 14 | 16 | 18 | nCK |
| nRCD | | 11 | 13 | 15 | 17 | 19 | nCK |
| nRC | | 39 | 45 | 51 | 56 | 62 | nCK |
| nRAS | | 28 | 32 | 36 | 39 | 43 | nCK |
| nRP | | 11 | 13 | 15 | 17 | 19 | nCK |
| nFAW | x4 | 16 | 16 | 16 | 16 | 16 | nCK |
| | x8 | 20 | 22 | 23 | 26 | 28 | nCK |
| nRRDS | x4 | 4 | 4 | 4 | 4 | 4 | nCK |
| | x8 | 4 | 4 | 4 | 4 | 4 | nCK |
| nRRDL | x4 | 5 | 5 | 6 | 6 | 7 | nCK |
| | x8 | 5 | 5 | 6 | 6 | 7 | nCK |
| tCCD_S | | 4 | 4 | 4 | 4 | 4 | nCK |
| tCCD_L | | 5 | 5 | 6 | 6 | 7 | nCK |
| tWTR_S | | 2 | 3 | 3 | 3 | 4 | nCK |
| tWTR_L | | 6 | 7 | 8 | 9 | 10 | nCK |
| nRFC 2Gb | | 128 | 150 | 171 | 193 | 214 | nCK |
| nRFC 4Gb | | 208 | 243 | 278 | 313 | 347 | nCK |
| nRFC 8Gb | | 280 | 327 | 374 | 421 | 467 | nCK |
| nRFC 16Gb | | 440 | 514 | 587 | 661 | 734 | nCK |

[Table 37] Basic IDD, IPP and IDDQ Measurement Conditions

| Symbol | Description |
|--------------------|---|
| IDD0 | Operating One Bank Active-Precharge Current (AL=0) CKE: High; External clock: On; tCK, nRC, nRAS, CL: see Table 36; BL: 8 ¹⁾ ; AL: 0; CS_n: High between ACT and PRE; Command, Address, Bank Group Address, Bank Address Inputs: partially toggling according to Table 38; Data IO: VDDQ; DM_n: stable at 1; Bank Activity: Cycling with one bank active at a time: 0,0,1,1,2,2,... (see Table 38); Output Buffer and RTT: Enabled in Mode Registers ²⁾ ; ODT Signal: stable at 0; Pattern Details: see Table 38 |
| IDD0A | Operating One Bank Active-Precharge Current (AL=CL-1) AL = CL-1, Other conditions: see IDD0 |
| IPP0 | Operating One Bank Active-Precharge IPP Current Same condition with IDD0 |
| IDD1 | Operating One Bank Active-Read-Precharge Current (AL=0) CKE: High; External clock: On; tCK, nRC, nRAS, nRCD, CL: see Table 36; BL: 8 ¹⁾ ; AL: 0; CS_n: High between ACT, RD and PRE; Command, Address, Bank Group Address, Bank Address Inputs, Data IO: partially toggling according to Table 39; DM_n: stable at 1; Bank Activity: Cycling with one bank active at a time: 0,0,1,1,2,2,... (see Table 39); Output Buffer and RTT: Enabled in Mode Registers ²⁾ ; ODT Signal: stable at 0; Pattern Details: see Table 39 |
| IDD1A | Operating One Bank Active-Read-Precharge Current (AL=CL-1) AL = CL-1, Other conditions: see IDD1 |
| IPP1 | Operating One Bank Active-Read-Precharge IPP Current Same condition with IDD1 |
| IDD2N | Precharge Standby Current (AL=0) CKE: High; External clock: On; tCK, CL: see Table 36; BL: 8 ¹⁾ ; AL: 0; CS_n: stable at 1; Command, Address, Bank Group Address, Bank Address Inputs: partially toggling according to Table 40; Data IO: VDDQ; DM_n: stable at 1; Bank Activity: all banks closed; Output Buffer and RTT: Enabled in Mode Registers ²⁾ ; ODT Signal: stable at 0; Pattern Details: see Table 40 |
| IDD2NA | Precharge Standby Current (AL=CL-1) AL = CL-1, Other conditions: see IDD2N |
| IPP2N | Precharge Standby IPP Current Same condition with IDD2N |
| IDD2NT | Precharge Standby ODT Current CKE: High; External clock: On; tCK, CL: see Table 36; BL: 8 ¹⁾ ; AL: 0; CS_n: stable at 1; Command, Address, Bank Group Address, Bank Address Inputs: partially toggling according to Table 41; Data IO: VSSQ; DM_n: stable at 1; Bank Activity: all banks closed; Output Buffer and RTT: Enabled in Mode Registers ²⁾ ; ODT Signal: toggling according to Table 41; Pattern Details: see Table 41 |
| IDDQ2NT (Optional) | Precharge Standby ODT IDDQ Current Same definition like for IDD2NT, however measuring IDDQ current instead of IDD current |
| IDD2NL | Precharge Standby Current with CAL enabled Same definition like for IDD2N, CAL enabled ³⁾ |
| IDD2NG | Precharge Standby Current with Gear Down mode enabled Same definition like for IDD2N, Gear Down mode enabled ^{3),5)} |
| IDD2ND | Precharge Standby Current with DLL disabled Same definition like for IDD2N, DLL disabled ³⁾ |
| IDD2N_par | Precharge Standby Current with CA parity enabled Same definition like for IDD2N, CA parity enabled ³⁾ |
| IDD2P | Precharge Power-Down Current CKE: Low; External clock: On; tCK, CL: see Table 36; BL: 8 ¹⁾ ; AL: 0; CS_n: stable at 1; Command, Address, Bank Group Address, Bank Address Inputs: stable at 0; Data IO: VDDQ; DM_n: stable at 1; Bank Activity: all banks closed; Output Buffer and RTT: Enabled in Mode Registers ²⁾ ; ODT Signal: stable at 0 |
| IPP2P | Precharge Power-Down IPP Current Same condition with IDD2P |
| IDD2Q | Precharge Quiet Standby Current CKE: High; External clock: On; tCK, CL: see Table 36; BL: 8 ¹⁾ ; AL: 0; CS_n: stable at 1; Command, Address, Bank Group Address, Bank Address Inputs: stable at 0; Data IO: VDDQ; DM_n: stable at 1; Bank Activity: all banks closed; Output Buffer and RTT: Enabled in Mode Registers ²⁾ ; ODT Signal: stable at 0 |
| IDD3N | Active Standby Current CKE: High; External clock: On; tCK, CL: see Table 36; BL: 8 ¹⁾ ; AL: 0; CS_n: stable at 1; Command, Address, Bank Group Address, Bank Address Inputs: partially toggling according to Table 40; Data IO: VDDQ; DM_n: stable at 1; Bank Activity: all banks open; Output Buffer and RTT: Enabled in Mode Registers ²⁾ ; ODT Signal: stable at 0; Pattern Details: see Table 40 |

[Table 37] Basic IDD, IPP and IDDQ Measurement Conditions

| Symbol | Description |
|-----------------------|---|
| IDD3NA | Active Standby Current (AL=CL-1) AL = CL-1, Other conditions: see IDD3N |
| IPP3N | Active Standby IPP Current Same condition with IDD3N |
| IDD3P | Active Power-Down Current CKE: Low; External clock: On; tCK, CL: see Table 36; BL: 8 ¹ ; AL: 0; CS_n: stable at 1; Command, Address, Bank Group Address, Bank Address Inputs: stable at 0; Data IO: VDDQ; DM_n: stable at 1; Bank Activity: all banks open; Output Buffer and RTT: Enabled in Mode Registers ² ; ODT Signal: stable at 0 |
| IPP3P | Active Power-Down IPP Current Same condition with IDD3P |
| IDD4R | Operating Burst Read Current CKE: High; External clock: On; tCK, CL: see Table 36; BL: 8 ² ; AL: 0; CS_n: High between RD; Command, Address, Bank Group Address, Bank Address Inputs: partially toggling according to Table 42; Data IO: seamless read data burst with different data between one burst and the next one according to Table 42; DM_n: stable at 1; Bank Activity: all banks open, RD commands cycling through banks: 0,0,1,1,2,2,... (see Table 42); Output Buffer and RTT: Enabled in Mode Registers ² ; ODT Signal: stable at 0; Pattern Details: see Table 42 |
| IDD4RA | Operating Burst Read Current (AL=CL-1) AL = CL-1, Other conditions: see IDD4R |
| IDD4RB | Operating Burst Read Current with Read DBI Read DBI enabled ³ , Other conditions: see IDD4R |
| IPP4R | Operating Burst Read IPP Current Same condition with IDD4R |
| IDDQ4R (Optional) | Operating Burst Read IDDQ Current Same definition like for IDD4R, however measuring IDDQ current instead of IDD current |
| IDDQ4RB (Optional) | Operating Burst Read IDDQ Current with Read DBI Same definition like for IDD4RB, however measuring IDDQ current instead of IDD current |
| IDD4W | Operating Burst Write Current CKE: High; External clock: On; tCK, CL: see Table 36; BL: 8 ¹ ; AL: 0; CS_n: High between WR; Command, Address, Bank Group Address, Bank Address Inputs: partially toggling according to Table 43; Data IO: seamless write data burst with different data between one burst and the next one according to Table 43; DM_n: stable at 1; Bank Activity: all banks open, WR commands cycling through banks: 0,0,1,1,2,2,... (see Table 43); Output Buffer and RTT: Enabled in Mode Registers ² ; ODT Signal: stable at HIGH; Pattern Details: see Table 43 |
| IDD4WA | Operating Burst Write Current (AL=CL-1) AL = CL-1, Other conditions: see IDD4W |
| IDD4WB | Operating Burst Write Current with Write DBI Write DBI enabled ³ , Other conditions: see IDD4W |
| IDD4WC | Operating Burst Write Current with Write CRC Write CRC enabled ³ , Other conditions: see IDD4W |
| IDD4W_par | Operating Burst Write Current with CA Parity CA Parity enabled ³ , Other conditions: see IDD4W |
| IPP4W | Operating Burst Write IPP Current Same condition with IDD4W |
| IDD5B | Burst Refresh Current (1X REF) CKE: High; External clock: On; tCK, CL, nRFC: see Table 36; BL: 8 ¹ ; AL: 0; CS_n: High between REF; Command, Address, Bank Group Address, Bank Address Inputs: partially toggling according to Table 45; Data IO: VDDQ; DM_n: stable at 1; Bank Activity: REF command every nRFC (see Table 45); Output Buffer and RTT: Enabled in Mode Registers ² ; ODT Signal: stable at 0; Pattern Details: see Table 45 |
| IPP5B | Burst Refresh Write IPP Current (1X REF) Same condition with IDD5B |
| IDD5F2 | Burst Refresh Current (2X REF) tRFC=tRFC_x2, Other conditions: see IDD5B |
| IPP5F2 | Burst Refresh Write IPP Current (2X REF) Same condition with IDD5F2 |
| IDD5F4 | Burst Refresh Current (4X REF) tRFC=tRFC_x4, Other conditions: see IDD5B |
| IPP5F4 | Burst Refresh Write IPP Current (4X REF) Same condition with IDD5F4 |

[Table 37] Basic IDD, IPP and IDDQ Measurement Conditions

| Symbol | Description |
|--------|--|
| IDD6N | Self Refresh Current: Normal Temperature Range T _{CASE} : 0 - 85°C; Low Power Auto Self Refresh (LP ASR) : Normal ⁴); CKE : Low; External clock : Off; CK _t and CK _{c#} : LOW; CL : see Table 36; BL : 8 ¹); AL : 0; CS_{n#}, Command, Address, Bank Group Address, Bank Address, Data IO : High; DM_n : stable at 1; Bank Activity : Self-Refresh operation; Output Buffer and RTT : Enabled in Mode Registers ²); ODT Signal : MID-LEVEL |
| IPP6N | Self Refresh IPP Current: Normal Temperature Range Same condition with IDD6N |
| IDD6E | Self-Refresh Current: Extended Temperature Range ¹ T _{CASE} : 0 - 95°C; Low Power Auto Self Refresh (LP ASR) : Extended ⁴); CKE : Low; External clock : Off; CK _t and CK _c : LOW; CL : see Table 36; BL : 8 ¹); AL : 0; CS_n, Command, Address, Bank Group Address, Bank Address, Data IO : High; DM_n : stable at 1; Bank Activity : Extended Temperature Self-Refresh operation; Output Buffer and RTT : Enabled in Mode Registers ²); ODT Signal : MID-LEVEL |
| IPP6E | Self Refresh IPP Current: Extended Temperature Range Same condition with IDD6E |
| IDD6R | Self-Refresh Current: Reduced Temperature Range T _{CASE} : 0 - 45°C; Low Power Auto Self Refresh (LP ASR) : Reduced ⁴); CKE : Low; External clock : Off; CK _t and CK _{c#} : LOW; CL : see Table 36; BL : 8 ¹); AL : 0; CS_{n#}, Command, Address, Bank Group Address, Bank Address, Data IO : High; DM_n : stable at 1; Bank Activity : Extended Temperature Self-Refresh operation; Output Buffer and RTT : Enabled in Mode Registers ²); ODT Signal : MID-LEVEL |
| IPP6R | Self Refresh IPP Current: Reduced Temperature Range Same condition with IDD6R |
| IDD6A | Auto Self-Refresh Current T _{CASE} : 0 - 95°C; Low Power Auto Self Refresh (LP ASR) : Auto ⁴); CKE : Low; External clock : Off; CK _t and CK _{c#} : LOW; CL : see Table 36; BL : 8 ¹); AL : 0; CS_{n#}, Command, Address, Bank Group Address, Bank Address, Data IO : High; DM_n : stable at 1; Bank Activity : Auto Self-Refresh operation; Output Buffer and RTT : Enabled in Mode Registers ²); ODT Signal : MID-LEVEL |
| IPP6A | Auto Self-Refresh IPP Current Same condition with IDD6A |
| IDD7 | Operating Bank Interleave Read Current CKE : High; External clock : On; tCK, nRC, nRAS, nRCD, nRRD, nFAW, CL : see Table 36; BL : 8 ¹); AL : CL-1; CS_n : High between ACT and RDA; Command, Address, Bank Group Address, Bank Address Inputs : partially toggling according to Table 46; Data IO : read data bursts with different data between one burst and the next one according to Table 46; DM_n : stable at 1; Bank Activity : two times interleaved cycling through banks (0, 1, ...7) with different addressing, see Table 46; Output Buffer and RTT : Enabled in Mode Registers ²); ODT Signal : stable at 0; Pattern Details : see Table 46 |
| IPP7 | Operating Bank Interleave Read IPP Current Same condition with IDD7 |
| IDD8 | Maximum Power Down Current TBD |
| IPP8 | Maximum Power Down IPP Current Same condition with IDD8 |

NOTE:

- Burst Length: BL8 fixed by MRS: set MR0 [A1:0=00].
- Output Buffer Enable
 - set MR1 [A12 = 0]: Qoff = Output buffer enabled
 - set MR1 [A2:1 = 00]: Output Driver Impedance Control = RZQ/7
- CAL enabled: set MR4 [A8:6 = 001]: 1600MT/s
 - 010]: 1866MT/s, 2133MT/s
 - 011]: 2400MT/s, 2666MT/s
- Gear Down mode enabled: set MR3 [A3 = 1]: 1/4 Rate
DLL disabled: set MR1 [A0 = 0]
CA parity enabled: set MR5 [A2:0 = 001]: 1600MT/s, 1866MT/s, 2133MT/s
 - 010]: 2400MT/s, 2666MT/s
- Read DBI enabled: set MR5 [A12 = 1]
Write DBI enabled: set MR5 [A11 = 1]
- Low Power Array Self Refresh (LP ASR): set MR2 [A7:6 = 00]: Normal
 - 01]: Reduced Temperature range
 - 10]: Extended Temperature range
 - 11]: Auto Self Refresh
- IDD2NG should be measured after sync pulses (NOP) input.

[Table 38] IDD0, IDD0A and IPP0 Measurement-Loop Pattern ¹⁾

| CK_t/CK_c | CKE | Sub-Loop | Cycle Number | Command | CS_n | ACT_n | RAS_n/A16 | CAS_n/A15 | WE_n/A14 | ODT | C[2:0] ³⁾ | BG[1:0] ²⁾ | BA[1:0] | A12/BC_n | A[17,13,11] | A[10]/AP | A[9:7] | A[6:3] | A[2:0] | Data ⁴⁾ | | | | |
|-----------|-------------|---|--------------|---|------|-------|-----------|-----------|----------|-----|----------------------|-----------------------|-----------------|----------|-------------|----------|--------|--------|--------|--------------------|---|---|---|---|
| toggling | Static High | 0 | 0 | ACT | 0 | 0 | 0 | 0 | 0 | 0 | 0 | 0 | 0 | 0 | 0 | 0 | 0 | 0 | 0 | 0 | - | | | |
| | | | 1,2 | D, D | 1 | 0 | 0 | 0 | 0 | 0 | 0 | 0 | 0 | 0 | 0 | 0 | 0 | 0 | 0 | 0 | 0 | 0 | - | |
| | | | 3,4 | D_#, D_# | 1 | 1 | 1 | 1 | 1 | 1 | 0 | 0 | 3 ²⁾ | 3 | 0 | 0 | 0 | 7 | F | 0 | 0 | 0 | - | |
| | | | ... | repeat pattern 1...4 until nRAS - 1, truncate if necessary | | | | | | | | | | | | | | | | | | | | |
| | | | nRAS | PRE | 0 | 1 | 0 | 1 | 0 | 0 | 0 | 0 | 0 | 0 | 0 | 0 | 0 | 0 | 0 | 0 | 0 | 0 | 0 | - |
| | | | ... | repeat pattern 1...4 until nRC - 1, truncate if necessary | | | | | | | | | | | | | | | | | | | | |
| | | 1 | 1*nRC | repeat Sub-Loop 0, use BG[1:0]²⁾ = 1, BA[1:0] = 1 instead | | | | | | | | | | | | | | | | | | | | |
| | | 2 | 2*nRC | repeat Sub-Loop 0, use BG[1:0]²⁾ = 0, BA[1:0] = 2 instead | | | | | | | | | | | | | | | | | | | | |
| | | 3 | 3*nRC | repeat Sub-Loop 0, use BG[1:0]²⁾ = 1, BA[1:0] = 3 instead | | | | | | | | | | | | | | | | | | | | |
| | | 4 | 4*nRC | repeat Sub-Loop 0, use BG[1:0]²⁾ = 0, BA[1:0] = 1 instead | | | | | | | | | | | | | | | | | | | | |
| | | 5 | 5*nRC | repeat Sub-Loop 0, use BG[1:0]²⁾ = 1, BA[1:0] = 2 instead | | | | | | | | | | | | | | | | | | | | |
| | | 6 | 6*nRC | repeat Sub-Loop 0, use BG[1:0]²⁾ = 0, BA[1:0] = 3 instead | | | | | | | | | | | | | | | | | | | | |
| | | 7 | 7*nRC | repeat Sub-Loop 0, use BG[1:0]²⁾ = 1, BA[1:0] = 0 instead | | | | | | | | | | | | | | | | | | | | |
| | | 8 | 8*nRC | repeat Sub-Loop 0, use BG[1:0]²⁾ = 2, BA[1:0] = 0 instead | | | | | | | | | | | | | | | | | | | | |
| | | 9 | 9*nRC | repeat Sub-Loop 0, use BG[1:0]²⁾ = 3, BA[1:0] = 1 instead | | | | | | | | | | | | | | | | | | | | |
| 10 | 10*nRC | repeat Sub-Loop 0, use BG[1:0]²⁾ = 2, BA[1:0] = 2 instead | | | | | | | | | | | | | | | | | | | | | | |
| 11 | 11*nRC | repeat Sub-Loop 0, use BG[1:0]²⁾ = 3, BA[1:0] = 3 instead | | | | | | | | | | | | | | | | | | | | | | |
| 12 | 12*nRC | repeat Sub-Loop 0, use BG[1:0]²⁾ = 2, BA[1:0] = 1 instead | | | | | | | | | | | | | | | | | | | | | | |
| 13 | 13*nRC | repeat Sub-Loop 0, use BG[1:0]²⁾ = 3, BA[1:0] = 2 instead | | | | | | | | | | | | | | | | | | | | | | |
| 14 | 14*nRC | repeat Sub-Loop 0, use BG[1:0]²⁾ = 2, BA[1:0] = 3 instead | | | | | | | | | | | | | | | | | | | | | | |
| 15 | 15*nRC | repeat Sub-Loop 0, use BG[1:0]²⁾ = 3, BA[1:0] = 0 instead | | | | | | | | | | | | | | | | | | | | | | |

NOTE :
 1) DQS_t, DQS_c are VDDQ.
 2) BG1 is don't care for x16 device
 3) C[2:0] are used only for 3DS device
 4) DQ signals are VDDQ.

For x4 and x8 only

[Table 39] IDD1, IDD1A and IPP1 Measurement-Loop Pattern¹⁾

| CK _t , CK _c | CKE | Sub-Loop | Cycle Number | Command | CS _n | ACT _n | RAS _{n/A16} | CAS _{n/A15} | WE _{n/A14} | ODT | C[2:0] ³⁾ | BG[1:0] ²⁾ | BA[1:0] | A12/BC _n | A[17,13,11] | A[10]/AP | A[9:7] | A[6:3] | A[2:0] | Data ⁴⁾ | | | |
|-----------------------------------|-------------|---|-------------------|--|-----------------|------------------|----------------------|----------------------|---------------------|-----|----------------------|-----------------------|-----------------|---------------------|-------------|----------|--------|--------|--------|--------------------|---|---|--|
| toggling | Static High | 0 | 0 | ACT | 0 | 0 | 0 | 0 | 0 | 0 | 0 | 0 | 0 | 0 | 0 | 0 | 0 | 0 | 0 | 0 | - | | |
| | | | 1, 2 | D, D | 1 | 0 | 0 | 0 | 0 | 0 | 0 | 0 | 0 | 0 | 0 | 0 | 0 | 0 | 0 | 0 | 0 | - | |
| | | | 3, 4 | D#, D# | 1 | 1 | 1 | 1 | 1 | 1 | 0 | 0 | 3 ^{b)} | 3 | 0 | 0 | 0 | 0 | 7 | F | 0 | - | |
| | | | ... | repeat pattern 1...4 until nRCD - AL - 1, truncate if necessary | | | | | | | | | | | | | | | | | | | |
| | | | nRCD -AL | RD | 0 | 1 | 1 | 0 | 1 | 0 | 0 | 0 | 0 | 0 | 0 | 0 | 0 | 0 | 0 | 0 | 0 | 0 | D0=00, D1=FF D2=FF, D3=00 D4=FF, D5=00 D6=00, D7=FF |
| | | | ... | repeat pattern 1...4 until nRAS - 1, truncate if necessary | | | | | | | | | | | | | | | | | | | |
| | | | nRAS | PRE | 0 | 1 | 0 | 1 | 0 | 0 | 0 | 0 | 0 | 0 | 0 | 0 | 0 | 0 | 0 | 0 | 0 | 0 | - |
| | | | ... | repeat pattern 1...4 until nRC - 1, truncate if necessary | | | | | | | | | | | | | | | | | | | |
| | | 1 | 1*nRC + 0 | ACT | 0 | 0 | 0 | 1 | 1 | 0 | 0 | 1 | 1 | 0 | 0 | 0 | 0 | 0 | 0 | 0 | 0 | - | |
| | | | 1*nRC + 1, 2 | D, D | 1 | 0 | 0 | 0 | 0 | 0 | 0 | 0 | 0 | 0 | 0 | 0 | 0 | 0 | 0 | 0 | 0 | - | |
| | | | 1*nRC + 3, 4 | D#, D# | 1 | 1 | 1 | 1 | 1 | 1 | 0 | 0 | 3 ^{b)} | 3 | 0 | 0 | 0 | 0 | 7 | F | 0 | - | |
| | | | ... | repeat pattern nRC + 1...4 until 1*nRC + nRAS - 1, truncate if necessary | | | | | | | | | | | | | | | | | | | |
| | | | 1*nRC + nRCD - AL | RD | 0 | 1 | 1 | 0 | 1 | 0 | 0 | 0 | 1 | 1 | 0 | 0 | 0 | 0 | 0 | 0 | 0 | 0 | D0=FF, D1=00 D2=00, D3=FF D4=00, D5=FF D6=FF, D7=00 |
| | | | ... | repeat pattern 1...4 until nRAS - 1, truncate if necessary | | | | | | | | | | | | | | | | | | | |
| | | | 1*nRC + nRAS | PRE | 0 | 1 | 0 | 1 | 0 | 0 | 1 | 1 | 0 | 0 | 0 | 0 | 0 | 0 | 0 | 0 | 0 | 0 | - |
| | | | ... | repeat nRC + 1...4 until 2*nRC - 1, truncate if necessary | | | | | | | | | | | | | | | | | | | |
| | | 2 | 2*nRC | repeat Sub-Loop 0, use BG[1:0] ²⁾ = 0, BA[1:0] = 2 instead | | | | | | | | | | | | | | | | | | | |
| | | 3 | 3*nRC | repeat Sub-Loop 1, use BG[1:0] ²⁾ = 1, BA[1:0] = 3 instead | | | | | | | | | | | | | | | | | | | |
| | | 4 | 4*nRC | repeat Sub-Loop 0, use BG[1:0] ²⁾ = 0, BA[1:0] = 1 instead | | | | | | | | | | | | | | | | | | | |
| | | 5 | 5*nRC | repeat Sub-Loop 1, use BG[1:0] ²⁾ = 1, BA[1:0] = 2 instead | | | | | | | | | | | | | | | | | | | |
| | | 6 | 6*nRC | repeat Sub-Loop 0, use BG[1:0] ²⁾ = 0, BA[1:0] = 3 instead | | | | | | | | | | | | | | | | | | | |
| | | 8 | 7*nRC | repeat Sub-Loop 1, use BG[1:0] ²⁾ = 1, BA[1:0] = 0 instead | | | | | | | | | | | | | | | | | | | |
| | | 9 | 9*nRC | repeat Sub-Loop 1, use BG[1:0] ²⁾ = 2, BA[1:0] = 0 instead | | | | | | | | | | | | | | | | | | | |
| | | 10 | 10*nRC | repeat Sub-Loop 0, use BG[1:0] ²⁾ = 3, BA[1:0] = 1 instead | | | | | | | | | | | | | | | | | | | |
| | | 11 | 11*nRC | repeat Sub-Loop 1, use BG[1:0] ²⁾ = 2, BA[1:0] = 2 instead | | | | | | | | | | | | | | | | | | | |
| | | 12 | 12*nRC | repeat Sub-Loop 0, use BG[1:0] ²⁾ = 3, BA[1:0] = 3 instead | | | | | | | | | | | | | | | | | | | |
| | | 13 | 13*nRC | repeat Sub-Loop 1, use BG[1:0] ²⁾ = 2, BA[1:0] = 1 instead | | | | | | | | | | | | | | | | | | | |
| | | 14 | 14*nRC | repeat Sub-Loop 0, use BG[1:0] ²⁾ = 3, BA[1:0] = 2 instead | | | | | | | | | | | | | | | | | | | |
| 15 | 15*nRC | repeat Sub-Loop 1, use BG[1:0] ²⁾ = 2, BA[1:0] = 3 instead | | | | | | | | | | | | | | | | | | | | | |
| 16 | 16*nRC | repeat Sub-Loop 0, use BG[1:0] ²⁾ = 3, BA[1:0] = 0 instead | | | | | | | | | | | | | | | | | | | | | |

For x4 and x8 only

NOTE :
 1) DQS_t, DQS_c are used according to RD Commands, otherwise VDDQ.
 2) BG1 is don't care for x16 device.
 3) C[2:0] are used only for 3DS device.
 4) Burst Sequence driven on each DQ signal by Read Command. Outside burst operation, DQ signals are VDDQ.

[Table 40] IDD2N, IDD2NA, IDD2NL, IDD2NG, IDD2ND, IDD2N_par, IPP2,IDD3N, IDD3NA and IDD3P Measurement-Loop Pattern¹⁾

| CK_t, CK_c | CKE | Sub-Loop | Cycle Number | Command | CS_n | ACT_n | RAS_n/A16 | CAS_n/A15 | WE_n/A14 | ODT | C[2:0] ³⁾ | BG[1:0] ²⁾ | BA[1:0] | A12/BC_n | A[17,13,11] | A[10]/AP | A[9:7] | A[6:3] | A[2:0] | Data ⁴⁾ | | |
|------------|-------------|---|--------------|---|------|-------|-----------|-----------|----------|-----|----------------------|-----------------------|-----------------|----------|-------------|----------|--------|--------|--------|--------------------|---|---|
| toggling | Static High | 0 | 0 | D, D | 1 | 0 | 0 | 0 | 0 | 0 | 0 | 0 | 0 | 0 | 0 | 0 | 0 | 0 | 0 | 0 | 0 | |
| | | | 1 | D, D | 1 | 0 | 0 | 0 | 0 | 0 | 0 | 0 | 0 | 0 | 0 | 0 | 0 | 0 | 0 | 0 | 0 | 0 |
| | | | 2 | D#, D# | 1 | 1 | 1 | 1 | 1 | 1 | 0 | 0 | 3 ²⁾ | 3 | 0 | 0 | 0 | 7 | F | 0 | 0 | 0 |
| | | | 3 | D#, D# | 1 | 1 | 1 | 1 | 1 | 1 | 0 | 0 | 3 ²⁾ | 3 | 0 | 0 | 0 | 7 | F | 0 | 0 | 0 |
| | | 1 | 4-7 | repeat Sub-Loop 0, use BG[1:0]²⁾ = 1, BA[1:0] = 1 instead | | | | | | | | | | | | | | | | | | |
| | | 2 | 8-11 | repeat Sub-Loop 0, use BG[1:0]²⁾ = 0, BA[1:0] = 2 instead | | | | | | | | | | | | | | | | | | |
| | | 3 | 12-15 | repeat Sub-Loop 0, use BG[1:0]²⁾ = 1, BA[1:0] = 3 instead | | | | | | | | | | | | | | | | | | |
| | | 4 | 16-19 | repeat Sub-Loop 0, use BG[1:0]²⁾ = 0, BA[1:0] = 1 instead | | | | | | | | | | | | | | | | | | |
| | | 5 | 20-23 | repeat Sub-Loop 0, use BG[1:0]²⁾ = 1, BA[1:0] = 2 instead | | | | | | | | | | | | | | | | | | |
| | | 6 | 24-27 | repeat Sub-Loop 0, use BG[1:0]²⁾ = 0, BA[1:0] = 3 instead | | | | | | | | | | | | | | | | | | |
| | | 7 | 28-31 | repeat Sub-Loop 0, use BG[1:0]²⁾ = 1, BA[1:0] = 0 instead | | | | | | | | | | | | | | | | | | |
| | | 8 | 32-35 | repeat Sub-Loop 0, use BG[1:0]²⁾ = 2, BA[1:0] = 0 instead | | | | | | | | | | | | | | | | | | |
| | | 9 | 36-39 | repeat Sub-Loop 0, use BG[1:0]²⁾ = 3, BA[1:0] = 1 instead | | | | | | | | | | | | | | | | | | |
| | | 10 | 40-43 | repeat Sub-Loop 0, use BG[1:0]²⁾ = 2, BA[1:0] = 2 instead | | | | | | | | | | | | | | | | | | |
| | | 11 | 44-47 | repeat Sub-Loop 0, use BG[1:0]²⁾ = 3, BA[1:0] = 3 instead | | | | | | | | | | | | | | | | | | |
| | | 12 | 48-51 | repeat Sub-Loop 0, use BG[1:0]²⁾ = 2, BA[1:0] = 1 instead | | | | | | | | | | | | | | | | | | |
| 13 | 52-55 | repeat Sub-Loop 0, use BG[1:0]²⁾ = 3, BA[1:0] = 2 instead | | | | | | | | | | | | | | | | | | | | |
| 14 | 56-59 | repeat Sub-Loop 0, use BG[1:0]²⁾ = 2, BA[1:0] = 3 instead | | | | | | | | | | | | | | | | | | | | |
| 15 | 60-63 | repeat Sub-Loop 0, use BG[1:0]²⁾ = 3, BA[1:0] = 0 instead | | | | | | | | | | | | | | | | | | | | |

- NOTE :**
 1) DQS_t, DQS_c are VDDQ.
 2) BG1 is don't care for x16 device.
 3) C[2:0] are used only for 3DS device.
 4) DQ signals are VDDQ.

[Table 41] IDD2NT and IDDQ2NT Measurement-Loop Pattern¹⁾

| CK _t , CK _c | CKE | Sub-Loop | Cycle Number | Command | CS _n | ACT _n | RAS _n /A16 | CAS _n /A15 | WE _n /A14 | ODT | C[2:0] ³⁾ | BG[1:0] ²⁾ | BA[1:0] | A12/BC _n | A[17,13,11] | A[10]/AP | A[9:7] | A[6:3] | A[2:0] | Data ⁴⁾ | | |
|-----------------------------------|-------------|---|--------------|---|-----------------|------------------|-----------------------|-----------------------|----------------------|-----|----------------------|-----------------------|-----------------|---------------------|-------------|----------|--------|--------|--------|--------------------|---|---|
| toggling | Static High | 0 | 0 | D, D | 1 | 0 | 0 | 0 | 0 | 0 | 0 | 0 | 0 | 0 | 0 | 0 | 0 | 0 | 0 | 0 | - | |
| | | | 1 | D, D | 1 | 0 | 0 | 0 | 0 | 0 | 0 | 0 | 0 | 0 | 0 | 0 | 0 | 0 | 0 | 0 | 0 | - |
| | | | 2 | D#, D# | 1 | 1 | 1 | 1 | 1 | 1 | 0 | 0 | 3 ²⁾ | 3 | 0 | 0 | 0 | 0 | 7 | F | 0 | - |
| | | | 3 | D#, D# | 1 | 1 | 1 | 1 | 1 | 1 | 0 | 0 | 3 ²⁾ | 3 | 0 | 0 | 0 | 0 | 7 | F | 0 | - |
| | | 1 | 4-7 | repeat Sub-Loop 0, but ODT = 1 and BG[1:0] ²⁾ = 1, BA[1:0] = 1 instead | | | | | | | | | | | | | | | | | | |
| | | 2 | 8-11 | repeat Sub-Loop 0, but ODT = 0 and BG[1:0] ²⁾ = 0, BA[1:0] = 2 instead | | | | | | | | | | | | | | | | | | |
| | | 3 | 12-15 | repeat Sub-Loop 0, but ODT = 1 and BG[1:0] ²⁾ = 1, BA[1:0] = 3 instead | | | | | | | | | | | | | | | | | | |
| | | 4 | 16-19 | repeat Sub-Loop 0, but ODT = 0 and BG[1:0] ²⁾ = 0, BA[1:0] = 1 instead | | | | | | | | | | | | | | | | | | |
| | | 5 | 20-23 | repeat Sub-Loop 0, but ODT = 1 and BG[1:0] ²⁾ = 1, BA[1:0] = 2 instead | | | | | | | | | | | | | | | | | | |
| | | 6 | 24-27 | repeat Sub-Loop 0, but ODT = 0 and BG[1:0] ²⁾ = 0, BA[1:0] = 3 instead | | | | | | | | | | | | | | | | | | |
| | | 7 | 28-31 | repeat Sub-Loop 0, but ODT = 1 and BG[1:0] ²⁾ = 1, BA[1:0] = 0 instead | | | | | | | | | | | | | | | | | | |
| | | 8 | 32-35 | repeat Sub-Loop 0, but ODT = 0 and BG[1:0] ²⁾ = 2, BA[1:0] = 0 instead | | | | | | | | | | | | | | | | | | |
| | | 9 | 36-39 | repeat Sub-Loop 0, but ODT = 1 and BG[1:0] ²⁾ = 3, BA[1:0] = 1 instead | | | | | | | | | | | | | | | | | | |
| | | 10 | 40-43 | repeat Sub-Loop 0, but ODT = 0 and BG[1:0] ²⁾ = 2, BA[1:0] = 2 instead | | | | | | | | | | | | | | | | | | |
| | | 11 | 44-47 | repeat Sub-Loop 0, but ODT = 1 and BG[1:0] ²⁾ = 3, BA[1:0] = 3 instead | | | | | | | | | | | | | | | | | | |
| 12 | 48-51 | repeat Sub-Loop 0, but ODT = 0 and BG[1:0] ²⁾ = 2, BA[1:0] = 1 instead | | | | | | | | | | | | | | | | | | | | |
| 13 | 52-55 | repeat Sub-Loop 0, but ODT = 1 and BG[1:0] ²⁾ = 3, BA[1:0] = 2 instead | | | | | | | | | | | | | | | | | | | | |
| 14 | 56-59 | repeat Sub-Loop 0, but ODT = 0 and BG[1:0] ²⁾ = 2, BA[1:0] = 3 instead | | | | | | | | | | | | | | | | | | | | |
| 15 | 60-63 | repeat Sub-Loop 0, but ODT = 1 and BG[1:0] ²⁾ = 3, BA[1:0] = 0 instead | | | | | | | | | | | | | | | | | | | | |

For x4 and x8 only

- NOTE :
- 1) DQS_t, DQS_c are VDDQ.
 - 2) BG1 is don't care for x16 device.
 - 3) C[2:0] are used only for 3DS device.
 - 4) DQ signals are VDDQ.

[Table 42] IDD4R, IDDR4RA, IDD4RB and IDDQ4R Measurement-Loop Pattern¹⁾

| CK_t, CK_c | CKE | Sub-Loop | Cycle Number | Command | CS_n | ACT_n | RAS_n/A16 | CAS_n/A15 | WE_n/A14 | ODT | C[2:0] ³⁾ | BG[1:0] ²⁾ | BA[1:0] | A12/BC_n | A[17,13,11] | A[10]/AP | A[9:7] | A[6:3] | A[2:0] | Data ⁴⁾ | | | |
|------------|-------------|---|--------------|---|------|-------|-----------|-----------|----------|-----|----------------------|-----------------------|---------|-----------------|-------------|----------|--------|--------|--------|--------------------|--|--|---|
| toggling | Static High | 0 | 0 | RD | 0 | 1 | 1 | 0 | 1 | 0 | 0 | 0 | 0 | 0 | 0 | 0 | 0 | 0 | 0 | 0 | D0=00, D1=FF D2=FF, D3=00 D4=FF, D5=00 D6=00, D7=FF | | |
| | | | 1 | D | 1 | 0 | 0 | 0 | 0 | 0 | 0 | 0 | 0 | 0 | 0 | 0 | 0 | 0 | 0 | 0 | 0 | - | |
| | | | 2,3 | D#, D# | 1 | 1 | 1 | 1 | 1 | 1 | 0 | 0 | 0 | 3 ²⁾ | 3 | 0 | 0 | 0 | 7 | F | 0 | - | |
| | | 1 | 4 | RD | 0 | 1 | 1 | 0 | 1 | 0 | 0 | 0 | 0 | 1 | 1 | 0 | 0 | 0 | 7 | F | 0 | D0=FF, D1=00 D2=00, D3=FF D4=00, D5=FF D6=FF, D7=00 | |
| | | | 5 | D | 1 | 0 | 0 | 0 | 0 | 0 | 0 | 0 | 0 | 0 | 0 | 0 | 0 | 0 | 0 | 0 | 0 | 0 | - |
| | | | 6,7 | D#, D# | 1 | 1 | 1 | 1 | 1 | 1 | 0 | 0 | 0 | 3 ²⁾ | 3 | 0 | 0 | 0 | 7 | F | 0 | - | |
| | | 2 | 8-11 | repeat Sub-Loop 0, use BG[1:0]²⁾ = 0, BA[1:0] = 2 instead | | | | | | | | | | | | | | | | | | | |
| | | 3 | 12-15 | repeat Sub-Loop 1, use BG[1:0]²⁾ = 1, BA[1:0] = 3 instead | | | | | | | | | | | | | | | | | | | |
| | | 4 | 16-19 | repeat Sub-Loop 0, use BG[1:0]²⁾ = 0, BA[1:0] = 1 instead | | | | | | | | | | | | | | | | | | | |
| | | 5 | 20-23 | repeat Sub-Loop 1, use BG[1:0]²⁾ = 1, BA[1:0] = 2 instead | | | | | | | | | | | | | | | | | | | |
| | | 6 | 24-27 | repeat Sub-Loop 0, use BG[1:0]²⁾ = 0, BA[1:0] = 3 instead | | | | | | | | | | | | | | | | | | | |
| | | 7 | 28-31 | repeat Sub-Loop 1, use BG[1:0]²⁾ = 1, BA[1:0] = 0 instead | | | | | | | | | | | | | | | | | | | |
| | | 8 | 32-35 | repeat Sub-Loop 0, use BG[1:0]²⁾ = 2, BA[1:0] = 0 instead | | | | | | | | | | | | | | | | | | | |
| | | 9 | 36-39 | repeat Sub-Loop 1, use BG[1:0]²⁾ = 3, BA[1:0] = 1 instead | | | | | | | | | | | | | | | | | | | |
| | | 10 | 40-43 | repeat Sub-Loop 0, use BG[1:0]²⁾ = 2, BA[1:0] = 2 instead | | | | | | | | | | | | | | | | | | | |
| | | 11 | 44-47 | repeat Sub-Loop 1, use BG[1:0]²⁾ = 3, BA[1:0] = 3 instead | | | | | | | | | | | | | | | | | | | |
| 12 | 48-51 | repeat Sub-Loop 0, use BG[1:0]²⁾ = 2, BA[1:0] = 1 instead | | | | | | | | | | | | | | | | | | | | | |
| 13 | 52-55 | repeat Sub-Loop 1, use BG[1:0]²⁾ = 3, BA[1:0] = 2 instead | | | | | | | | | | | | | | | | | | | | | |
| 14 | 56-59 | repeat Sub-Loop 0, use BG[1:0]²⁾ = 2, BA[1:0] = 3 instead | | | | | | | | | | | | | | | | | | | | | |
| 15 | 60-63 | repeat Sub-Loop 1, use BG[1:0]²⁾ = 3, BA[1:0] = 0 instead | | | | | | | | | | | | | | | | | | | | | |
| | | | | | | | | | | | | | | | | | | | | For x4 and x8 only | | | |

NOTE :
 1) DQS_t, DQS_c are used according to RD Commands, otherwise VDDQ.
 2) BG1 is don't care for x16 device.
 3) C[2:0] are used only for 3DS device.
 4) Burst Sequence driven on each DQ signal by Read Command.

[Table 43] IDD4W, IDD4WA, IDD4WB and IDD4W_par Measurement-Loop Pattern¹⁾

| CK_t, CK_c | CKE | Sub-Loop | Cycle Number | Command | CS_n | ACT_n | RAS_n/A16 | CAS_n/A15 | WE_n/A14 | ODT | C[2:0] ³⁾ | BG[1:0] ²⁾ | BA[1:0] | A12/BC_n | A[17,13,11] | A[10]/AP | A[9:7] | A[6:3] | A[2:0] | Data ⁴⁾ | | | |
|------------|-------------|---|--------------|---|------|-------|-----------|-----------|----------|-----|----------------------|-----------------------|-----------------|----------|-------------|----------|--------|--------|--------|--------------------|--|--|---|
| toggling | Static High | 0 | 0 | WR | 0 | 1 | 1 | 0 | 0 | 1 | 0 | 0 | 0 | 0 | 0 | 0 | 0 | 0 | 0 | 0 | D0=00, D1=FF D2=FF, D3=00 D4=FF, D5=00 D6=00, D7=FF | | |
| | | | 1 | D | 1 | 0 | 0 | 0 | 0 | 0 | 1 | 0 | 0 | 0 | 0 | 0 | 0 | 0 | 0 | 0 | 0 | - | |
| | | | 2,3 | D#, D# | 1 | 1 | 1 | 1 | 1 | 1 | 1 | 0 | 3 ²⁾ | 3 | 0 | 0 | 0 | 0 | 7 | F | 0 | - | |
| | | 1 | 4 | WR | 0 | 1 | 1 | 0 | 0 | 0 | 1 | 0 | 0 | 1 | 1 | 0 | 0 | 0 | 7 | F | 0 | D0=FF, D1=00 D2=00, D3=FF D4=00, D5=FF D6=FF, D7=00 | |
| | | | 5 | D | 1 | 0 | 0 | 0 | 0 | 0 | 1 | 0 | 0 | 0 | 0 | 0 | 0 | 0 | 0 | 0 | 0 | 0 | - |
| | | | 6,7 | D#, D# | 1 | 1 | 1 | 1 | 1 | 1 | 1 | 0 | 3 ²⁾ | 3 | 0 | 0 | 0 | 0 | 7 | F | 0 | - | |
| | | 2 | 8-11 | repeat Sub-Loop 0, use BG[1:0]²⁾ = 0, BA[1:0] = 2 instead | | | | | | | | | | | | | | | | | | | |
| | | 3 | 12-15 | repeat Sub-Loop 1, use BG[1:0]²⁾ = 1, BA[1:0] = 3 instead | | | | | | | | | | | | | | | | | | | |
| | | 4 | 16-19 | repeat Sub-Loop 0, use BG[1:0]²⁾ = 0, BA[1:0] = 1 instead | | | | | | | | | | | | | | | | | | | |
| | | 5 | 20-23 | repeat Sub-Loop 1, use BG[1:0]²⁾ = 1, BA[1:0] = 2 instead | | | | | | | | | | | | | | | | | | | |
| | | 6 | 24-27 | repeat Sub-Loop 0, use BG[1:0]²⁾ = 0, BA[1:0] = 3 instead | | | | | | | | | | | | | | | | | | | |
| | | 7 | 28-31 | repeat Sub-Loop 1, use BG[1:0]²⁾ = 1, BA[1:0] = 0 instead | | | | | | | | | | | | | | | | | | | |
| | | 8 | 32-35 | repeat Sub-Loop 0, use BG[1:0]²⁾ = 2, BA[1:0] = 0 instead | | | | | | | | | | | | | | | | | | | |
| | | 9 | 36-39 | repeat Sub-Loop 1, use BG[1:0]²⁾ = 3, BA[1:0] = 1 instead | | | | | | | | | | | | | | | | | | | |
| | | 10 | 40-43 | repeat Sub-Loop 0, use BG[1:0]²⁾ = 2, BA[1:0] = 2 instead | | | | | | | | | | | | | | | | | | | |
| 11 | 44-47 | repeat Sub-Loop 1, use BG[1:0]²⁾ = 3, BA[1:0] = 3 instead | | | | | | | | | | | | | | | | | | | | | |
| 12 | 48-51 | repeat Sub-Loop 0, use BG[1:0]²⁾ = 2, BA[1:0] = 1 instead | | | | | | | | | | | | | | | | | | | | | |
| 13 | 52-55 | repeat Sub-Loop 1, use BG[1:0]²⁾ = 3, BA[1:0] = 2 instead | | | | | | | | | | | | | | | | | | | | | |
| 14 | 56-59 | repeat Sub-Loop 0, use BG[1:0]²⁾ = 2, BA[1:0] = 3 instead | | | | | | | | | | | | | | | | | | | | | |
| 15 | 60-63 | repeat Sub-Loop 1, use BG[1:0]²⁾ = 3, BA[1:0] = 0 instead | | | | | | | | | | | | | | | | | | | | | |

NOTE :
 1) DQS_t, DQS_c are used according to WR Commands, otherwise VDDQ.
 2) BG1 is don't care for x16 device.
 3) C[2:0] are used only for 3DS device.
 4) Burst Sequence driven on each DQ signal by Write Command.

For x4 and x8 only

[Table 44] IDD4WC Measurement-Loop Pattern¹⁾

| CK_t, CK_c | CKE | Sub-Loop | Cycle Number | Command | CS_n | ACT_n | RAS_n/A16 | CAS_n/A15 | WE_n/A14 | ODT | C[2:0] ³⁾ | BG[1:0] ²⁾ | BA[1:0] | A12/BC_n | A[17,13,11] | A[10]/AP | A[9:7] | A[6:3] | A[2:0] | Data ⁴⁾ | | |
|------------|-------------|---|--------------|---|------|-------|-----------|-----------|----------|-----|----------------------|-----------------------|---------|----------|-------------|----------|--------|--------|--------|--|--|---|
| toggling | Static High | 0 | 0 | WR | 0 | 1 | 1 | 0 | 0 | 1 | 0 | 0 | 0 | 0 | 0 | 0 | 0 | 0 | 0 | 0 | D0=00, D1=FF D2=FF, D3=00 D4=FF, D5=00 D6=00, D7=FF D8=CRC | |
| | | | 1,2 | D, D | 1 | 0 | 0 | 0 | 0 | 1 | 0 | 0 | 0 | 0 | 0 | 0 | 0 | 0 | 0 | 0 | 0 | - |
| | | | 3,4 | D#, D# | 1 | 1 | 1 | 1 | 1 | 1 | 0 | 3 ²⁾ | 3 | 0 | 0 | 0 | 0 | 7 | F | 0 | - | |
| | | | 5 | WR | 0 | 1 | 1 | 0 | 0 | 1 | 0 | 1 | 1 | 0 | 0 | 0 | 7 | F | 0 | D0=FF, D1=00 D2=00, D3=FF D4=00, D5=FF D6=FF, D7=00 D8=CRC | | |
| | | | 6,7 | D, D | 1 | 0 | 0 | 0 | 0 | 1 | 0 | 0 | 0 | 0 | 0 | 0 | 0 | 0 | 0 | 0 | - | |
| | | | 8,9 | D#, D# | 1 | 1 | 1 | 1 | 1 | 1 | 0 | 3 ²⁾ | 3 | 0 | 0 | 0 | 7 | F | 0 | - | | |
| | | 2 | 10-14 | repeat Sub-Loop 0, use BG[1:0]²⁾ = 0, BA[1:0] = 2 instead | | | | | | | | | | | | | | | | | | |
| | | 3 | 15-19 | repeat Sub-Loop 1, use BG[1:0]²⁾ = 1, BA[1:0] = 3 instead | | | | | | | | | | | | | | | | | | |
| | | 4 | 20-24 | repeat Sub-Loop 0, use BG[1:0]²⁾ = 0, BA[1:0] = 1 instead | | | | | | | | | | | | | | | | | | |
| | | 5 | 25-29 | repeat Sub-Loop 1, use BG[1:0]²⁾ = 1, BA[1:0] = 2 instead | | | | | | | | | | | | | | | | | | |
| | | 6 | 30-34 | repeat Sub-Loop 0, use BG[1:0]²⁾ = 0, BA[1:0] = 3 instead | | | | | | | | | | | | | | | | | | |
| | | 7 | 35-39 | repeat Sub-Loop 1, use BG[1:0]²⁾ = 1, BA[1:0] = 0 instead | | | | | | | | | | | | | | | | | | |
| | | 8 | 40-44 | repeat Sub-Loop 0, use BG[1:0]²⁾ = 2, BA[1:0] = 0 instead | | | | | | | | | | | | | | | | | | |
| | | 9 | 45-49 | repeat Sub-Loop 1, use BG[1:0]²⁾ = 3, BA[1:0] = 1 instead | | | | | | | | | | | | | | | | | | |
| | | 10 | 50-54 | repeat Sub-Loop 0, use BG[1:0]²⁾ = 2, BA[1:0] = 2 instead | | | | | | | | | | | | | | | | | | |
| 11 | 55-59 | repeat Sub-Loop 1, use BG[1:0]²⁾ = 3, BA[1:0] = 3 instead | | | | | | | | | | | | | | | | | | | | |
| 12 | 60-64 | repeat Sub-Loop 0, use BG[1:0]²⁾ = 2, BA[1:0] = 1 instead | | | | | | | | | | | | | | | | | | | | |
| 13 | 65-69 | repeat Sub-Loop 1, use BG[1:0]²⁾ = 3, BA[1:0] = 2 instead | | | | | | | | | | | | | | | | | | | | |
| 14 | 70-74 | repeat Sub-Loop 0, use BG[1:0]²⁾ = 2, BA[1:0] = 3 instead | | | | | | | | | | | | | | | | | | | | |
| 15 | 75-79 | repeat Sub-Loop 1, use BG[1:0]²⁾ = 3, BA[1:0] = 0 instead | | | | | | | | | | | | | | | | | | | | |

NOTE :

- 1) DQS_t, DQS_c are VDDQ.
- 2) BG1 is don't care for x16 device.
- 3) C[2:0] are used only for 3DS device.
- 4) Burst Sequence driven on each DQ signal by Write Command.

[Table 45] IDD5B Measurement-Loop Pattern¹⁾

| CK _t , CK _c | CKE | Sub-Loop | Cycle Number | Command | CS _n | ACT _n | RAS _n /A16 | CAS _n /A15 | WE _n /A14 | ODT | C[2:0] ³⁾ | BG[1:0] ²⁾ | BA[1:0] | A12/BC _n | A[17,13,11] | A[10]/AP | A[9:7] | A[6:3] | A[2:0] | Data ⁴⁾ | | | |
|-----------------------------------|-------------|----------|--|---|-----------------|------------------|-----------------------|-----------------------|----------------------|-----|----------------------|-----------------------|-----------------|---------------------|-------------|----------|--------|--------|--------|--------------------|---|---|---|
| toggling | Static High | 0 | 0 | REF | 1 | 0 | 0 | 0 | 0 | 0 | 0 | 0 | 0 | 0 | 0 | 0 | 0 | 0 | 0 | 0 | - | | |
| | | 1 | 1 | D | 1 | 0 | 0 | 0 | 0 | 0 | 0 | 0 | 0 | 0 | 0 | 0 | 0 | 0 | 0 | 0 | 0 | - | |
| | | 2 | 2 | D | 1 | 0 | 0 | 0 | 0 | 0 | 0 | 0 | 0 | 0 | 0 | 0 | 0 | 0 | 0 | 0 | 0 | 0 | - |
| | | 3 | 3 | D#, D# | 1 | 1 | 1 | 1 | 1 | 1 | 0 | 0 | 3 ²⁾ | 3 | 0 | 0 | 0 | 7 | F | 0 | 0 | - | |
| | | 4 | 4 | D#, D# | 1 | 1 | 1 | 1 | 1 | 1 | 0 | 0 | 3 ²⁾ | 3 | 0 | 0 | 0 | 7 | F | 0 | 0 | - | |
| | | 4-7 | repeat pattern 1...4, use BG[1:0] ²⁾ = 1, BA[1:0] = 1 instead | | | | | | | | | | | | | | | | | | | | |
| | | 8-11 | repeat pattern 1...4, use BG[1:0] ²⁾ = 0, BA[1:0] = 2 instead | | | | | | | | | | | | | | | | | | | | |
| | | 12-15 | repeat pattern 1...4, use BG[1:0] ²⁾ = 1, BA[1:0] = 3 instead | | | | | | | | | | | | | | | | | | | | |
| | | 16-19 | repeat pattern 1...4, use BG[1:0] ²⁾ = 0, BA[1:0] = 1 instead | | | | | | | | | | | | | | | | | | | | |
| | | 20-23 | repeat pattern 1...4, use BG[1:0] ²⁾ = 1, BA[1:0] = 2 instead | | | | | | | | | | | | | | | | | | | | |
| | | 24-27 | repeat pattern 1...4, use BG[1:0] ²⁾ = 0, BA[1:0] = 3 instead | | | | | | | | | | | | | | | | | | | | |
| | | 28-31 | repeat pattern 1...4, use BG[1:0] ²⁾ = 1, BA[1:0] = 0 instead | | | | | | | | | | | | | | | | | | | | |
| | | 32-35 | repeat pattern 1...4, use BG[1:0] ²⁾ = 2, BA[1:0] = 0 instead | | | | | | | | | | | | | | | | | | | | |
| | | 36-39 | repeat pattern 1...4, use BG[1:0] ²⁾ = 3, BA[1:0] = 1 instead | | | | | | | | | | | | | | | | | | | | |
| | | 40-43 | repeat pattern 1...4, use BG[1:0] ²⁾ = 2, BA[1:0] = 2 instead | | | | | | | | | | | | | | | | | | | | |
| | | 44-47 | repeat pattern 1...4, use BG[1:0] ²⁾ = 3, BA[1:0] = 3 instead | | | | | | | | | | | | | | | | | | | | |
| | | 48-51 | repeat pattern 1...4, use BG[1:0] ²⁾ = 2, BA[1:0] = 1 instead | | | | | | | | | | | | | | | | | | | | |
| | | 52-55 | repeat pattern 1...4, use BG[1:0] ²⁾ = 3, BA[1:0] = 2 instead | | | | | | | | | | | | | | | | | | | | |
| | | 56-59 | repeat pattern 1...4, use BG[1:0] ²⁾ = 2, BA[1:0] = 3 instead | | | | | | | | | | | | | | | | | | | | |
| | | 60-63 | repeat pattern 1...4, use BG[1:0] ²⁾ = 3, BA[1:0] = 0 instead | | | | | | | | | | | | | | | | | | | | |
| | | 2 | 64 ... nRFC - 1 | repeat Sub-Loop 1, Truncate, if necessary | | | | | | | | | | | | | | | | | | | |

For x4 and x8 only

- NOTE :
- 1) DQS_t, DQS_c are VDDQ.
 - 2) BG1 is don't care for x16 device.
 - 3) C[2:0] are used only for 3DS device.
 - 4) DQ signals are VDDQ.

[Table 46] IDD7 Measurement-Loop Pattern¹⁾

| CK_t, CK_c | CKE | Sub-Loop | Cycle Number | Command | CS_n | ACT_n | RAS_n/A16 | CAS_n/A15 | WE_n/A14 | ODT | C[2:0] ³⁾ | BG[1:0] ²⁾ | BA[1:0] | A12/BC_n | A[17,13,11] | A[10]/AP | A[9:7] | A[6:3] | A[2:0] | Data ⁴⁾ | | | |
|------------|-----------------|--|---|--|------|-------|-----------|-----------|----------|-----|----------------------|-----------------------|---------|-----------------|-------------|----------|--------|--------|--------|--------------------|---|--|--|
| toggling | Static High | 0 | 0 | ACT | 0 | 0 | 0 | 0 | 0 | 0 | 0 | 0 | 0 | 0 | 0 | 0 | 0 | 0 | 0 | 0 | - | | |
| | | | 1 | RDA | 0 | 1 | 1 | 0 | 1 | 0 | | | 0 | 0 | 0 | 0 | 1 | 0 | 0 | 0 | 0 | D0=00, D1=FF D2=FF, D3=00 D4=FF, D5=00 D6=00, D7=FF | |
| | | | 2 | D | 1 | 0 | 0 | 0 | 0 | 0 | 0 | 0 | 0 | 0 | 0 | 0 | 0 | 0 | 0 | 0 | 0 | 0 | - |
| | | | 3 | D# | 1 | 1 | 1 | 1 | 1 | 1 | 0 | 0 | 0 | 3 ²⁾ | 3 | 0 | 0 | 0 | 7 | F | 0 | 0 | - |
| | | | ... | repeat pattern 2...3 until nRRD - 1, if nRRD > 4. Truncate if necessary | | | | | | | | | | | | | | | | | | | |
| | | 1 | nRRD | ACT | 0 | 0 | 0 | 0 | 0 | 0 | 0 | 0 | 0 | 1 | 1 | 0 | 0 | 0 | 0 | 0 | 0 | 0 | - |
| | | | nRRD + 1 | RDA | 0 | 1 | 1 | 0 | 1 | 0 | | | | 1 | 1 | 0 | 0 | 1 | 0 | 0 | 0 | 0 | D0=FF, D1=00 D2=00, D3=FF D4=00, D5=FF D6=FF, D7=00 |
| | | ... | repeat pattern 2 ... 3 until 2*nRRD - 1, if nRRD > 4. Truncate if necessary | | | | | | | | | | | | | | | | | | | | |
| | | 2 | 2*nRRD | repeat Sub-Loop 0, use BG[1:0] ²⁾ = 0, BA[1:0] = 2 instead | | | | | | | | | | | | | | | | | | | |
| | | 3 | 3*nRRD | repeat Sub-Loop 1, use BG[1:0] ²⁾ = 1, BA[1:0] = 3 instead | | | | | | | | | | | | | | | | | | | |
| | | 4 | 4*nRRD | repeat pattern 2 ... 3 until nFAW - 1, if nFAW > 4*nRRD. Truncate if necessary | | | | | | | | | | | | | | | | | | | |
| | | 5 | nFAW | repeat Sub-Loop 0, use BG[1:0] ²⁾ = 0, BA[1:0] = 1 instead | | | | | | | | | | | | | | | | | | | |
| | | 6 | nFAW + nRRD | repeat Sub-Loop 1, use BG[1:0] ²⁾ = 1, BA[1:0] = 2 instead | | | | | | | | | | | | | | | | | | | |
| | | 7 | nFAW + 2*nRRD | repeat Sub-Loop 0, use BG[1:0] ²⁾ = 0, BA[1:0] = 3 instead | | | | | | | | | | | | | | | | | | | |
| | | 8 | nFAW + 3*nRRD | repeat Sub-Loop 1, use BG[1:0] ²⁾ = 1, BA[1:0] = 0 instead | | | | | | | | | | | | | | | | | | | |
| | | 9 | nFAW + 4*nRRD | repeat Sub-Loop 4 | | | | | | | | | | | | | | | | | | | |
| | | 10 | 2*nFAW | repeat Sub-Loop 0, use BG[1:0] ²⁾ = 2, BA[1:0] = 0 instead | | | | | | | | | | | | | | | | | | For x4 and x8 only | |
| | | 11 | 2*nFAW + nRRD | repeat Sub-Loop 1, use BG[1:0] ²⁾ = 3, BA[1:0] = 1 instead | | | | | | | | | | | | | | | | | | | |
| | | 12 | 2*nFAW + 2*nRRD | repeat Sub-Loop 0, use BG[1:0] ²⁾ = 2, BA[1:0] = 2 instead | | | | | | | | | | | | | | | | | | | |
| | | 13 | 2*nFAW + 3*nRRD | repeat Sub-Loop 1, use BG[1:0] ²⁾ = 3, BA[1:0] = 3 instead | | | | | | | | | | | | | | | | | | | |
| 14 | 2*nFAW + 4*nRRD | repeat Sub-Loop 4 | | | | | | | | | | | | | | | | | | | | | |
| 15 | 3*nFAW | repeat Sub-Loop 0, use BG[1:0] ²⁾ = 2, BA[1:0] = 1 instead | | | | | | | | | | | | | | | | | | | | | |
| 16 | 3*nFAW + nRRD | repeat Sub-Loop 1, use BG[1:0] ²⁾ = 3, BA[1:0] = 2 instead | | | | | | | | | | | | | | | | | | | | | |
| 17 | 3*nFAW + 2*nRRD | repeat Sub-Loop 0, use BG[1:0] ²⁾ = 2, BA[1:0] = 3 instead | | | | | | | | | | | | | | | | | | | | | |
| 18 | 3*nFAW + 3*nRRD | repeat Sub-Loop 1, use BG[1:0] ²⁾ = 3, BA[1:0] = 0 instead | | | | | | | | | | | | | | | | | | | | | |
| 19 | 3*nFAW + 4*nRRD | repeat Sub-Loop 4 | | | | | | | | | | | | | | | | | | | | | |
| 20 | 4*nFAW | repeat pattern 2 ... 3 until nRC - 1, if nRC > 4*nFAW. Truncate if necessary | | | | | | | | | | | | | | | | | | | | | |

NOTE:
 1) DQS_t, DQS_c are VDDQ.
 2) BG1 is don't care for x16 device.
 3) C[2:0] are used only for 3DS device.
 4) Burst Sequence driven on each DQ signal by Read Command. Outside burst operation, DQ signals are VDDQ.

14. IDD SPEC TABLE

IDD and IPP values are for typical operating range of voltage and temperature unless otherwise noted.

[Table 47] I_{DD} and I_{DDQ} Specification for M378A5244BB0

| Symbol | M378A5244BB0: 4GB(512Mx64) Module | | | | | | Unit | NOTE |
|-----------------|--------------------------------------|----------|-----------|----------|-----------|----------|------|------|
| | DDR4-2133 | | DDR4-2400 | | DDR4-2666 | | | |
| | 15-15-15 | | 17-17-17 | | 19-19-19 | | | |
| | VDD 1.2V | VPP 2.5V | VDD 1.2V | VPP 2.5V | VDD 1.2V | VPP 2.5V | | |
| | IDD Max. | IPP Max. | IDD Max. | IPP Max. | IDD Max. | IPP Max. | | |
| I_{DD0} | 168 | 16 | 171 | 16 | 172 | 16 | mA | |
| I_{DD0A} | 175 | 16 | 182 | 16 | 184 | 16 | mA | |
| I_{DD1} | 268 | 16 | 285 | 16 | 292 | 16 | mA | |
| I_{DD1A} | 278 | 16 | 296 | 16 | 300 | 16 | mA | |
| I_{DD2N} | 88 | 12 | 92 | 12 | 96 | 12 | mA | |
| I_{DD2NA} | 100 | 12 | 104 | 12 | 108 | 12 | mA | |
| I_{DD2NT} | 100 | 12 | 104 | 12 | 112 | 12 | mA | |
| I_{DD2NL} | 64 | 12 | 68 | 12 | 68 | 12 | mA | |
| I_{DD2NG} | 88 | 12 | 82 | 12 | 96 | 12 | mA | |
| I_{DD2ND} | 80 | 12 | 72 | 12 | 88 | 12 | mA | |
| I_{DD2N_par} | 92 | 12 | 96 | 12 | 100 | 12 | mA | |
| I_{DD2P} | 64 | 12 | 64 | 12 | 68 | 12 | mA | |
| I_{DD2Q} | 80 | 12 | 84 | 12 | 88 | 12 | mA | |
| I_{DD3N} | 144 | 12 | 144 | 12 | 144 | 12 | mA | |
| I_{DD3NA} | 152 | 12 | 152 | 12 | 152 | 12 | mA | |
| I_{DD3P} | 84 | 12 | 88 | 12 | 92 | 12 | mA | |
| I_{DD4R} | 651 | 12 | 762 | 12 | 780 | 12 | mA | |
| I_{DD4RA} | 665 | 12 | 710 | 12 | 800 | 12 | mA | |
| I_{DD4RB} | 644 | 12 | 692 | 12 | 776 | 12 | mA | |
| I_{DD4W} | 483 | 12 | 527 | 12 | 552 | 12 | mA | |
| I_{DD4WA} | 499 | 12 | 543 | 12 | 572 | 12 | mA | |
| I_{DD4WB} | 484 | 12 | 529 | 12 | 552 | 12 | mA | |
| I_{DD4WC} | 442 | 12 | 482 | 12 | 504 | 12 | mA | |
| I_{DD4W_par} | 513 | 12 | 580 | 12 | 588 | 12 | mA | |
| I_{DD5B} | 878 | 72 | 866 | 72 | 880 | 72 | mA | |
| I_{DD5F2} | 619 | 60 | 607 | 60 | 620 | 60 | mA | |
| I_{DD5F4} | 514 | 56 | 514 | 56 | 516 | 56 | mA | |
| I_{DD6N} | 92 | 16 | 92 | 16 | 96 | 16 | mA | |
| I_{DD6E} | 136 | 20 | 136 | 20 | 144 | 20 | mA | |
| I_{DD6R} | 64 | 14 | 64 | 14 | 64 | 16 | mA | |
| I_{DD6A} | 88 | 16 | 88 | 16 | 88 | 16 | mA | |
| I_{DD7} | 849 | 32 | 896 | 34 | 920 | 36 | mA | |
| I_{DD8} | 44 | 12 | 44 | 12 | 44 | 12 | mA | |

NOTE :

- 1) DIMM IDD SPEC is based on the condition that de-activated rank(IDLE) is IDD2N. Please refer to Table .
- 2) IDD current measure method and detail patterns are described on DDR4 component datasheet.
- 3) VDD and VDDQ are merged on module PCB (IDDQ values are not considered by Qoff condition)
- 4) DIMM IDD Values are calculated based on the component IDD spec and Register power.

[Table 48] I_{DD} and I_{DDQ} Specification for M378A1K43BB1 and M378A1K43BB2

| Symbol | M378A1K43BB1: 8GB(1Gx64) Module | | M378A1K43BB2: 8GB(1Gx64) Module | | | | Unit | NOTE |
|-----------------|------------------------------------|----------|------------------------------------|----------|-----------|----------|------|------|
| | DDR4-2133 | | DDR4-2400 | | DDR4-2666 | | | |
| | 15-15-15 | | 17-17-17 | | 19-19-19 | | | |
| | VDD 1.2V | VPP 2.5V | VDD 1.2V | VPP 2.5V | VDD 1.2V | VPP 2.5V | | |
| | IDD Max. | IPP Max. | IDD Max. | IPP Max. | IDD Max. | IPP Max. | | |
| I_{DD0} | 248 | 32 | 248 | 32 | 256 | 32 | mA | |
| I_{DD0A} | 256 | 32 | 272 | 32 | 280 | 32 | mA | |
| I_{DD1} | 352 | 32 | 360 | 32 | 360 | 32 | mA | |
| I_{DD1A} | 376 | 32 | 384 | 32 | 408 | 32 | mA | |
| I_{DD2N} | 176 | 24 | 184 | 24 | 184 | 24 | mA | |
| I_{DD2NA} | 200 | 24 | 208 | 24 | 208 | 24 | mA | |
| I_{DD2NT} | 200 | 24 | 208 | 24 | 208 | 24 | mA | |
| I_{DD2NL} | 120 | 24 | 136 | 24 | 136 | 24 | mA | |
| I_{DD2NG} | 176 | 24 | 184 | 24 | 184 | 24 | mA | |
| I_{DD2ND} | 160 | 24 | 168 | 24 | 168 | 24 | mA | |
| I_{DD2N_par} | 184 | 24 | 192 | 24 | 192 | 24 | mA | |
| I_{DD2P} | 128 | 24 | 128 | 24 | 128 | 24 | mA | |
| I_{DD2Q} | 160 | 24 | 168 | 24 | 168 | 24 | mA | |
| I_{DD3N} | 288 | 24 | 288 | 24 | 288 | 24 | mA | |
| I_{DD3NA} | 304 | 24 | 304 | 24 | 304 | 24 | mA | |
| I_{DD3P} | 168 | 24 | 176 | 24 | 176 | 24 | mA | |
| I_{DD4R} | 808 | 24 | 856 | 24 | 992 | 24 | mA | |
| I_{DD4RA} | 840 | 24 | 888 | 24 | 1040 | 24 | mA | |
| I_{DD4RB} | 816 | 24 | 872 | 24 | 1000 | 24 | mA | |
| I_{DD4W} | 672 | 24 | 712 | 24 | 808 | 24 | mA | |
| I_{DD4WA} | 704 | 24 | 752 | 24 | 848 | 24 | mA | |
| I_{DD4WB} | 672 | 24 | 720 | 24 | 816 | 24 | mA | |
| I_{DD4WC} | 592 | 24 | 664 | 24 | 752 | 24 | mA | |
| I_{DD4W_par} | 736 | 24 | 792 | 24 | 896 | 24 | mA | |
| I_{DD5B} | 1592 | 144 | 1592 | 144 | 1728 | 144 | mA | |
| I_{DD5F2} | 1104 | 120 | 1112 | 120 | 1200 | 120 | mA | |
| I_{DD5F4} | 928 | 112 | 936 | 112 | 1008 | 112 | mA | |
| I_{DD6N} | 184 | 32 | 184 | 32 | 192 | 32 | mA | |
| I_{DD6E} | 272 | 40 | 272 | 40 | 288 | 48 | mA | |
| I_{DD6R} | 128 | 28 | 128 | 28 | 128 | 32 | mA | |
| I_{DD6A} | 176 | 32 | 176 | 32 | 176 | 32 | mA | |
| I_{DD7} | 1136 | 64 | 1144 | 68 | 1240 | 72 | mA | |
| I_{DD8} | 88 | 24 | 88 | 24 | 88 | 24 | mA | |

NOTE :

- 1) DIMM IDD SPEC is based on the condition that de-activated rank(IDLE) is IDD2N. Please refer to Table .
- 2) IDD current measure method and detail patterns are described on DDR4 component datasheet.
- 3) VDD and VDDQ are merged on module PCB (IDDQ values are not considered by Qoff condition)
- 4) DIMM IDD Values are calculated based on the component IDD spec and Register power.

NOTE :

- 1) DIMM IDD SPEC is based on the condition that de-activated rank(IDLE) is IDD2N. Please refer to Table .
 2) IDD current measure method and detail patterns are described on DDR4 component datasheet.
 3) VDD and VDDQ are merged on module PCB (IDDQ values are not considered by Qoff condition)
 4) DIMM IDD Values are calculated based on the component IDD spec and Register power.

[Table 49] I_{DD} and I_{DDQ} Specification for M378A2K43BB1

| Symbol | M378A2K43BB1: 16GB(2Gx64) Module | | | | | | Unit | NOTE |
|-----------------|-------------------------------------|----------|-----------|----------|-----------|----------|------|------|
| | DDR4-2133 | | DDR4-2400 | | DDR4-2666 | | | |
| | 15-15-15 | | 17-17-17 | | 19-19-19 | | | |
| | VDD 1.2V | VPP 2.5V | VDD 1.2V | VPP 2.5V | VDD 1.2V | VPP 2.5V | | |
| | IDD Max. | IPP Max. | IDD Max. | IPP Max. | IDD Max. | IPP Max. | | |
| I_{DD0} | 424 | 56 | 432 | 56 | 440 | 56 | mA | |
| I_{DD0A} | 432 | 56 | 456 | 56 | 464 | 56 | mA | |
| I_{DD1} | 528 | 56 | 544 | 56 | 544 | 56 | mA | |
| I_{DD1A} | 552 | 56 | 568 | 56 | 592 | 56 | mA | |
| I_{DD2N} | 352 | 48 | 368 | 48 | 368 | 48 | mA | |
| I_{DD2NA} | 400 | 48 | 416 | 48 | 416 | 48 | mA | |
| I_{DD2NT} | 400 | 48 | 416 | 48 | 416 | 48 | mA | |
| I_{DD2NL} | 240 | 48 | 272 | 48 | 272 | 48 | mA | |
| I_{DD2NG} | 352 | 48 | 368 | 48 | 368 | 48 | mA | |
| I_{DD2ND} | 320 | 48 | 336 | 48 | 336 | 48 | mA | |
| I_{DD2N_par} | 368 | 48 | 384 | 48 | 384 | 48 | mA | |
| I_{DD2P} | 256 | 48 | 256 | 48 | 256 | 48 | mA | |
| I_{DD2Q} | 320 | 48 | 336 | 48 | 336 | 48 | mA | |
| I_{DD3N} | 576 | 48 | 576 | 48 | 576 | 48 | mA | |
| I_{DD3NA} | 608 | 48 | 608 | 48 | 608 | 48 | mA | |
| I_{DD3P} | 336 | 48 | 352 | 48 | 352 | 48 | mA | |
| I_{DD4R} | 984 | 48 | 1040 | 48 | 1176 | 48 | mA | |
| I_{DD4RA} | 1016 | 48 | 1072 | 48 | 1224 | 48 | mA | |
| I_{DD4RB} | 992 | 48 | 1056 | 48 | 1184 | 48 | mA | |
| I_{DD4W} | 848 | 48 | 896 | 48 | 992 | 48 | mA | |
| I_{DD4WA} | 880 | 48 | 936 | 48 | 1032 | 48 | mA | |
| I_{DD4WB} | 848 | 48 | 904 | 48 | 1000 | 48 | mA | |
| I_{DD4WC} | 768 | 48 | 848 | 48 | 936 | 48 | mA | |
| I_{DD4W_par} | 912 | 48 | 976 | 48 | 1080 | 48 | mA | |
| I_{DD5B} | 1768 | 168 | 1776 | 168 | 1912 | 168 | mA | |
| I_{DD5F2} | 1280 | 144 | 1296 | 144 | 1384 | 144 | mA | |
| I_{DD5F4} | 1104 | 136 | 1120 | 136 | 1192 | 136 | mA | |
| I_{DD6N} | 368 | 64 | 368 | 64 | 384 | 64 | mA | |
| I_{DD6E} | 544 | 80 | 544 | 80 | 576 | 96 | mA | |
| I_{DD6R} | 256 | 56 | 256 | 56 | 256 | 64 | mA | |
| I_{DD6A} | 352 | 64 | 352 | 64 | 352 | 64 | mA | |
| I_{DD7} | 1312 | 88 | 1328 | 92 | 1424 | 96 | mA | |
| I_{DD8} | 176 | 48 | 176 | 48 | 176 | 48 | mA | |

NOTE :

- 1) DIMM IDD SPEC is based on the condition that de-activated rank(IDLE) is IDD2N. Please refer to Table .
 2) IDD current measure method and detail patterns are described on DDR4 component datasheet.
 3) VDD and VDDQ are merged on module PCB (IDDQ values are not considered by Qoff condition)
 4) DIMM IDD Values are calculated based on the component IDD spec and Register power.

NOTE :

- 1) DIMM IDD SPEC is based on the condition that de-actived rank(IDLE) is IDD2N. Please refer to Table .
- 2) IDD current measure method and detail patterns are described on DDR4 component datasheet.
- 3) VDD and VDDQ are merged on module PCB (IDDQ values are not considered by Qoff condition)
- 4) DIMM IDD Values are calculated based on the component IDD spec and Register power.

[Table 50] DIMM Rank Status

| SEC DIMM | Operating Rank | The other Rank |
|------------|----------------|----------------|
| I_{DD0} | I_{DD0} | I_{DD2N} |
| I_{DD1} | I_{DD1} | I_{DD2N} |
| I_{DD2P} | I_{DD2P} | I_{DD2P} |
| I_{DD2N} | I_{DD2N} | I_{DD2N} |
| I_{DD2Q} | I_{DD2Q} | I_{DD2Q} |
| I_{DD3P} | I_{DD3P} | I_{DD3P} |
| I_{DD3N} | I_{DD3N} | I_{DD3N} |
| I_{DD4R} | I_{DD4R} | I_{DD2N} |
| I_{DD4W} | I_{DD4W} | I_{DD2N} |
| I_{DD5B} | I_{DD5B} | I_{DD2N} |
| I_{DD6} | I_{DD6} | I_{DD6} |
| I_{DD7} | I_{DD7} | I_{DD2N} |
| I_{DD8} | I_{DD8} | I_{DD8} |

15. INPUT/OUTPUT CAPACITANCE

[Table 51] Silicon Pad I/O Capacitance

| Symbol | Parameter | DDR4-1600/1866/2133 | | DDR4-2400/2666 | | Unit | NOTE |
|-------------------------|---|---------------------|------|----------------|------|------|----------|
| | | min | max | min | max | | |
| C _{IO} | Input/output capacitance | 0.55 | 1.4 | 0.55 | 1.15 | pF | 1,2,3 |
| C _{DIO} | Input/output capacitance delta | -0.1 | 0.1 | -0.1 | 0.1 | pF | 1,2,3,11 |
| C _{DDQS} | Input/output capacitance delta DQS _t and DQS _c | - | 0.05 | - | 0.05 | pF | 1,2,3,5 |
| C _{CK} | Input capacitance, CK _t and CK _c | 0.2 | 0.8 | 0.2 | 0.7 | pF | 1,3 |
| C _{DCK} | Input capacitance delta CK _t and CK _c | - | 0.05 | - | 0.05 | pF | 1,3,4 |
| C _I | Input capacitance (CTRL, ADD, CMD pins only) | 0.2 | 0.8 | 0.2 | 0.7 | pF | 1,3,6 |
| C _{DI_CTRL} | Input capacitance delta (All CTRL pins only) | -0.1 | 0.1 | -0.1 | 0.1 | pF | 1,3,7,8 |
| C _{DI_ADD_CMD} | Input capacitance delta (All ADD/CMD pins only) | -0.1 | 0.1 | -0.1 | 0.1 | pF | 1,2,9,10 |
| C _{ALERT} | Input/output capacitance of ALERT | 0.5 | 1.5 | 0.5 | 1.5 | pF | 1,3 |
| C _{ZQ} | Input/output capacitance of ZQ | - | 2.3 | - | 2.3 | pF | 1,3,12 |
| C _{TEN} | Input capacitance of TEN | 0.2 | 2.3 | 0.2 | 2.3 | pF | 1,3,13 |

NOTE :

- 1) This parameter is not subject to production test. It is verified by design and characterization. The silicon only capacitance is validated by de-embedding the package L & C parasitic. The capacitance is measured with VDD, VDDQ, VSS, VSSQ applied with all other signal pins floating. Measurement procedure tbd.
- 2) DQ, DM_n, DQS_T, DQS_c, TDQS_T, TDQS_C. Although the DM, TDQS_T and TDQS_C pins have different functions, the loading matches DQ and DQS
- 3) This parameter applies to monolithic devices only; stacked/dual-die devices are not covered here
- 4) Absolute value CK_T-CK_C
- 5) Absolute value of CIO(DQS_T)-CIO (DQS_c)
- 6) C_I applies to ODT, CS_n, CKE, A0-A17, BA0-BA1, BG0-BG1, RAS_n/A16, CAS_n/A15, WE_n/A14, ACT_n and PAR.
- 7) C_{DI_CTRL} applies to ODT, CS_n and CKE
- 8) C_{DI_CTRL} = C_I(CTRL)-0.5*(C_I(CLK_T)+C_I(CLK_C))
- 9) C_{DI_ADD_CMD} applies to, A0-A17, BA0-BA1, BG0-BG1,RAS_n/A16, CAS_n/A15, WE_n/A14, ACT_n and PAR.
- 10) C_{DI_ADD_CMD} = C_I(ADD_CMD)-0.5*(C_I(CLK_T)+C_I(CLK_C))
- 11) C_{DIO} = C_{IO}(DQ,DM)-0.5*(C_{IO}(DQS_T)+C_{IO}(DQS_c))
- 12) Maximum external load capacitance on ZQ pin: tbd pF.
- 13) TEN pin may be DRAM internally pulled low through a weak pull-down resistor to VSS. In this case C_{TEN} might not be valid and system shall verify TEN signal with Vendor specific information.

16. ELECTRICAL CHARACTERISTICS & AC TIMING

16.1 Reference Load for AC Timing and Output Slew Rate

Figure 23 represents the effective reference load of 50 ohms used in defining the relevant AC timing parameters of the device as well as output slew rate measurements.

Ron nominal of DQ, DQS_t and DQS_c drivers uses 34 ohms to specify the relevant AC timing parameter values of the device.

The maximum DC High level of Output signal = 1.0 * VDDQ,

The minimum DC Low level of Output signal = {34 / (34 + 50)} * VDDQ = 0.4 * VDDQ

The nominal reference level of an Output signal can be approximated by the following:

The center of maximum DC High and minimum DC Low = {(1 + 0.4) / 2} * VDDQ = 0.7 * VDDQ

The actual reference level of Output signal might vary with driver Ron and reference load tolerances. Thus, the actual reference level or midpoint of an output signal is at the widest part of the output signal's eye. Prior to measuring AC parameters, the reference level of the verification tool should be set to an appropriate level.

It is not intended as a precise representation of any particular system environment or a depiction of the actual load presented by a production tester. System designers should use IBIS or other simulation tools to correlate the timing reference load to a system environment. Manufacturers correlate to their production test conditions, generally one or more coaxial transmission lines terminated at the tester electronics.

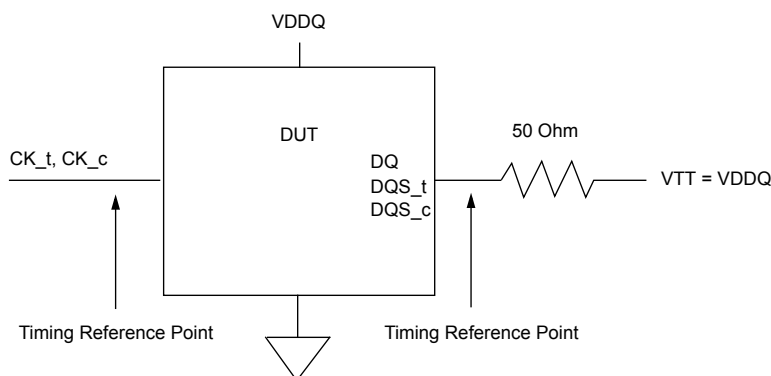

Figure 23. Reference Load for AC Timing and Output Slew Rate

16.2 tREFI

Average periodic Refresh interval (tREFI) of DDR4 SDRAM is defined as shown in the table.

[Table 52] tREFI by device density

| Parameter | Symbol | 2Gb | 4Gb | 8Gb | 16Gb | Units | NOTE | |
|---|--------|-----------------------------------|-----|-----|------|-------|------|---|
| All Bank Refresh to active/refresh cmd time | tRFC | 160 | 260 | 350 | 550 | ns | | |
| Average periodic refresh interval | tREFI | 0 °C ≤ T _{CASE} ≤ 85°C | 7.8 | 7.8 | 7.8 | 7.8 | μs | |
| | | -40 °C ≤ T _{CASE} ≤ 85°C | 7.8 | 7.8 | 7.8 | 7.8 | μs | 2 |
| | | 85 °C < T _{CASE} ≤ 95°C | 3.9 | 3.9 | 3.9 | 3.9 | μs | 1 |

- NOTE :**
- Users should refer to the DRAM supplier data sheet and/or the DIMM SPD to determine if DDR4 SDRAM devices support the following options or requirements referred to in this material.
 - Supported only for Industrial Temperature.

16.3 Clock Specification

The jitter specified is a random jitter meeting a Gaussian distribution. Input clocks violating the min/max values may result in malfunction of the DDR4 SDRAM device.

16.3.1 Definition for tCK(abs)

tCK(abs) is defined as the absolute clock period, as measured from one rising edge to the next consecutive rising edge. tCK(abs) is not subject to production test.

16.3.2 Definition for tCK(avg)

tCK(avg) is calculated as the average clock period across any consecutive 200 cycle window, where each clock period is calculated from rising edge to rising edge.

$$tCK(avg) = \left(\sum_{j=1}^N tCK(abs)_j \right) / N \quad N = 200$$

16.3.3 Definition for tCH(avg) and tCL(avg)

tCH(avg) is defined as the average high pulse width, as calculated across any consecutive 200 high pulses.

$$tCH(avg) = \left(\sum_{j=1}^N tCH_j \right) / \{N \times tCK(avg)\} \quad N = 200$$

tCL(avg) is defined as the average low pulse width, as calculated across any consecutive 200 low pulses.

$$tCL(avg) = \left(\sum_{j=1}^N tCL_j \right) / \{N \times tCK(avg)\} \quad N = 200$$

16.3.4 Definition for tERR(nper)

tERR is defined as the cumulative error across n consecutive cycles of n x tCK(avg). tERR is not subject to production test.

17. TIMING PARAMETERS BY SPEED GRADE

[Table 53] Timing Parameters by Speed Bin for DDR4-1600 to DDR4-2666

| Speed | | DDR4-1600 | | DDR4-1866 | | DDR4-2133 | | DDR4-2400 | | DDR4-2666 | | Units | NOTE |
|---|----------------|--|------|----------------------|-------|----------------------|--------|------------------|--------|------------------|--------|----------|-------|
| Parameter | Symbol | MIN | MAX | MIN | MAX | MIN | MAX | MIN | MAX | MIN | MAX | | |
| Clock Timing | | | | | | | | | | | | | |
| Minimum Clock Cycle Time (DLL off mode) | tCK(DLL_OFF) | 8 | 20 | 8 | 20 | 8 | 20 | 8 | 20 | 8 | 20 | ns | |
| Average Clock Period | tCK(avg) | 1.25 | <1.5 | 1.071 | <1.25 | 0.937 | <1.071 | 0.833 | <0.937 | 0.750 | <0.833 | ns | 35,36 |
| Average high pulse width | tCH(avg) | 0.48 | 0.52 | 0.48 | 0.52 | 0.48 | 0.52 | 0.48 | 0.52 | 0.48 | 0.52 | tCK(avg) | |
| Average low pulse width | tCL(avg) | 0.48 | 0.52 | 0.48 | 0.52 | 0.48 | 0.52 | 0.48 | 0.52 | 0.48 | 0.52 | tCK(avg) | |
| Absolute Clock Period | tCK(abs) | MIN : tCK(avg)min + tJIT(per)min_tot MAX : tCK(avg)max + tJIT(per)max_tot | | | | | | | | | | tCK(avg) | |
| Absolute clock HIGH pulse width | tCH(abs) | 0.45 | - | 0.45 | - | 0.45 | - | 0.45 | - | 0.45 | - | tCK(avg) | 23 |
| Absolute clock LOW pulse width | tCL(abs) | 0.45 | - | 0.45 | - | 0.45 | - | 0.45 | - | 0.45 | - | tCK(avg) | 24 |
| Clock Period Jitter- total | tJIT(per)_tot | -63 | 63 | -54 | 54 | -47 | 47 | -42 | 42 | -38 | 38 | ps | 23 |
| Clock Period Jitter- deterministic | tJIT(per)_dj | -31 | 31 | -27 | 27 | -23 | 23 | -21 | 21 | -19 | 19 | ps | 26 |
| Clock Period Jitter during DLL locking period | tJIT(per, lck) | -50 | 50 | -43 | 43 | -38 | 38 | -33 | 33 | -30 | 30 | ps | |
| Cycle to Cycle Period Jitter | tJIT(cc) | - | 125 | - | 107 | - | 94 | - | 83 | - | 75 | ps | |
| Cycle to Cycle Period Jitter during DLL locking period | tJIT(cc, lck) | - | 100 | - | 86 | - | 75 | - | 67 | - | 60 | ps | |
| Duty Cycle Jitter | tJIT(duty) | TBD | TBD | TBD | TBD | TBD | TBD | TBD | TBD | TBD | TBD | ps | |
| Cumulative error across 2 cycles | tERR(2per) | -92 | 92 | -79 | 79 | -69 | 69 | -61 | 61 | -55 | 55 | ps | |
| Cumulative error across 3 cycles | tERR(3per) | -109 | 109 | -94 | 94 | -82 | 82 | -73 | 73 | -66 | 66 | ps | |
| Cumulative error across 4 cycles | tERR(4per) | -121 | 121 | -104 | 104 | -91 | 91 | -81 | 81 | -73 | 73 | ps | |
| Cumulative error across 5 cycles | tERR(5per) | -131 | 131 | -112 | 112 | -98 | 98 | -87 | 87 | -78 | 78 | ps | |
| Cumulative error across 6 cycles | tERR(6per) | -139 | 139 | -119 | 119 | -104 | 104 | -92 | 92 | -83 | 83 | ps | |
| Cumulative error across 7 cycles | tERR(7per) | -145 | 145 | -124 | 124 | -109 | 109 | -97 | 97 | -87 | 87 | ps | |
| Cumulative error across 8 cycles | tERR(8per) | -151 | 151 | -129 | 129 | -113 | 113 | -101 | 101 | -91 | 91 | ps | |
| Cumulative error across 9 cycles | tERR(9per) | -156 | 156 | -134 | 134 | -117 | 117 | -104 | 104 | -94 | 94 | ps | |
| Cumulative error across 10 cycles | tERR(10per) | -160 | 160 | -137 | 137 | -120 | 120 | -107 | 107 | -96 | 96 | ps | |
| Cumulative error across 11 cycles | tERR(11per) | -164 | 164 | -141 | 141 | -123 | 123 | -110 | 110 | -99 | 99 | ps | |
| Cumulative error across 12 cycles | tERR(12per) | -168 | 168 | -144 | 144 | -126 | 126 | -112 | 112 | -101 | 101 | ps | |
| Cumulative error across 13 cycles | tERR(13per) | -172 | 172 | -147 | 147 | -129 | 129 | -114 | 114 | -103 | 103 | ps | |
| Cumulative error across 14 cycles | tERR(14per) | -175 | 175 | -150 | 150 | -131 | 131 | -116 | 116 | -104 | 104 | ps | |
| Cumulative error across 15 cycles | tERR(15per) | -178 | 178 | -152 | 152 | -133 | 133 | -118 | 118 | -106 | 106 | ps | |
| Cumulative error across 16 cycles | tERR(16per) | -180 | 189 | -155 | 155 | -135 | 135 | -120 | 120 | -108 | 108 | ps | |
| Cumulative error across 17 cycles | tERR(17per) | -183 | 183 | -157 | 157 | -137 | 137 | -122 | 122 | -110 | 110 | ps | |
| Cumulative error across 18 cycles | tERR(18per) | -185 | 185 | -159 | 159 | -139 | 139 | -124 | 124 | -112 | 112 | ps | |
| Cumulative error across n = 13, 14 . . . 49, 50 cycles | tERR(nper) | MIN : tERR(nper)min = ((1 + 0.68ln(n)) * tJIT(per)_total min) MAX : tERR(nper)max = ((1 + 0.68ln(n)) * tJIT(per)_total max) | | | | | | | | | | ps | |
| Command and Address setup time to CK_t, CK_c referenced to Vih(ac) / Vil(ac) levels | tIS(base) | 115 | - | 100 | - | 80 | - | 62 | - | 55 | - | ps | |
| Command and Address setup time to CK_t, CK_c referenced to Vref levels | tIS(Vref) | 215 | - | 200 | - | 180 | - | 162 | - | 145 | - | ps | |
| Command and Address hold time to CK_t, CK_c referenced to Vih(dc) / Vil(dc) levels | tIH(base) | 140 | - | 125 | - | 105 | - | 87 | - | 80 | - | ps | |
| Command and Address hold time to CK_t, CK_c referenced to Vref levels | tIH(Vref) | 215 | - | 200 | - | 180 | - | 162 | - | 145 | - | ps | |
| Control and Address Input pulse width for each input | tIPW | 600 | - | 525 | - | 460 | - | 410 | - | 385 | - | ps | |
| Command and Address Timing | | | | | | | | | | | | | |
| CAS_n to CAS_n command delay for same bank group | tCCD_L | max(5 nCK, 6.250 ns) | - | max(5 nCK, 5.355 ns) | - | max(5 nCK, 5.355 ns) | - | max(5 nCK, 5 ns) | - | max(5 nCK, 5 ns) | - | nCK | 34 |
| CAS_n to CAS_n command delay for different bank group | tCCD_S | 4 | - | 4 | - | 4 | - | 4 | - | 4 | - | nCK | 34 |
| ACTIVATE to ACTIVATE Command delay to different bank group for 2KB page size | tRRD_S(2K) | Max(4nCK, 6 ns) | - | Max(4nCK, 5.3ns) | - | Max(4nCK, 5.3ns) | - | Max(4nCK, 5.3ns) | - | Max(4nCK, 5.3ns) | - | nCK | 34 |
| ACTIVATE to ACTIVATE Command delay to different bank group for 2KB page size | tRRD_S(1K) | Max(4nCK, 5 ns) | - | Max(4nCK, 4.2ns) | - | Max(4nCK, 3.7ns) | - | Max(4nCK, 3.3ns) | - | Max(4nCK, 3 ns) | - | nCK | 34 |
| ACTIVATE to ACTIVATE Command delay to different bank group for 1/2KB page size | tRRD_S(1/2K) | Max(4nCK, 5 ns) | - | Max(4nCK, 4.2ns) | - | Max(4nCK, 3.7ns) | - | Max(4nCK, 3.3ns) | - | Max(4nCK, 3 ns) | - | nCK | 34 |
| ACTIVATE to ACTIVATE Command delay to same bank group for 2KB page size | tRRD_L(2K) | Max(4nCK, 7.5ns) | - | Max(4nCK, 6.4ns) | - | Max(4nCK, 6.4ns) | - | Max(4nCK, 6.4ns) | - | Max(4nCK, 6.4ns) | - | nCK | 34 |
| ACTIVATE to ACTIVATE Command delay to same bank group for 1KB page size | tRRD_L(1K) | Max(4nCK, 6 ns) | - | Max(4nCK, 5.3ns) | - | Max(4nCK, 5.3ns) | - | Max(4nCK, 4.9ns) | - | Max(4nCK, 4.3ns) | - | nCK | 34 |

[Table 53] Timing Parameters by Speed Bin for DDR4-1600 to DDR4-2666

| Speed | | DDR4-1600 | | DDR4-1866 | | DDR4-2133 | | DDR4-2400 | | DDR4-2666 | | Units | NOTE |
|---|---------------|--|---------|-------------------------|---------|-------------------------|---------|-------------------------|---------|-------------------------|---------|------------|----------------|
| Parameter | Symbol | MIN | MAX | MIN | MAX | MIN | MAX | MIN | MAX | MIN | MAX | | |
| ACTIVATE to ACTIVATE Command delay to same bank group for 1/2KB page size | tRRD_L(1/2K) | Max(4nCK,6 ns) | - | Max(4nCK,5.3ns) | - | Max(4nCK,5.3ns) | - | Max(4nCK,4.9ns) | - | Max(4nCK,4.9ns) | - | nCK | 34 |
| Four activate window for 2KB page size | tFAW_2K | Max(28nCK,35ns) | - | Max(28nCK,30ns) | - | Max(28nCK,30ns) | - | Max(28nCK,30ns) | - | Max(28nCK,30ns) | - | ns | 34 |
| Four activate window for 1KB page size | tFAW_1K | Max(20nCK,25ns) | - | Max(20nCK,23ns) | - | Max(20nCK,21ns) | - | Max(20nCK,21ns) | - | Max(20nCK,21ns) | - | ns | 34 |
| Four activate window for 1/2KB page size | tFAW_1/2K | Max(16nCK,20ns) | - | Max(16nCK,17ns) | - | Max(16nCK,15ns) | - | Max(16nCK,13ns) | - | Max(16nCK,12ns) | - | ns | 34 |
| Delay from start of internal write transaction to internal read command for different bank group | tWTR_S | max(2nCK,2.5ns) | - | max(2nCK,2.5ns) | - | max(2nCK,2.5ns) | - | Max(2nCK,2.5ns) | - | Max(2nCK,2.5ns) | - | ns | 1,2,e,34 |
| Delay from start of internal write transaction to internal read command for same bank group | tWTR_L | max(4nCK,7.5ns) | - | max(4nCK,7.5ns) | - | max(4nCK,7.5ns) | - | max(4nCK,7.5ns) | - | max(4nCK,7.5ns) | - | ns | 1,34 |
| Internal READ Command to PRE-CHARGE Command delay | tRTP | max(4nCK,7.5ns) | - | max(4nCK,7.5ns) | - | max(4nCK,7.5ns) | - | max(4nCK,7.5ns) | - | max(4nCK,7.5ns) | - | ns | |
| WRITE recovery time | tWR | 15 | - | 15 | - | 15 | - | 15 | - | 15 | - | ns | 1 |
| Write recovery time when CRC and DM are enabled | tWR_CRC_DM | tWR+max(4nCK,3.75ns) | - | tWR+max(5nCK,3.75ns) | - | tWR+max(5nCK,3.75ns) | - | tWR+max(5nCK,3.75ns) | - | tWR+max(5nCK,3.75ns) | - | ns | 1,28 |
| Delay from start of internal write transaction to internal read command for different bank group with both CRC and DM enabled | tWTR_S_CRC_DM | tWTR_S+max(4nCK,3.75ns) | - | tWTR_S+max(5nCK,3.75ns) | - | tWTR_S+max(5nCK,3.75ns) | - | tWTR_S+max(5nCK,3.75ns) | - | tWTR_S+max(5nCK,3.75ns) | - | ns | 2,29,34 |
| Delay from start of internal write transaction to internal read command for same bank group with both CRC and DM enabled | tWTR_L_CRC_DM | tWTR_L+max(4nCK,3.75ns) | - | tWTR_L+max(5nCK,3.75ns) | - | tWTR_L+max(5nCK,3.75ns) | - | tWTR_L+max(5nCK,3.75ns) | - | tWTR_L+max(5nCK,3.75ns) | - | ns | 3,30,34 |
| DLL locking time | tDLLK | 597 | - | 597 | - | 768 | - | 768 | - | 1024 | - | nCK | |
| Mode Register Set command cycle time | tMRD | 8 | - | 8 | - | 8 | - | 8 | - | 8 | - | nCK | |
| Mode Register Set command update delay | tMOD | max(24nCK,15ns) | - | max(24nCK,15ns) | - | max(24nCK,15ns) | - | max(24nCK,15ns) | - | max(24nCK,15ns) | - | nCK | 50 |
| Multi-Purpose Register Recovery Time | tMPRR | 1 | - | 1 | - | 1 | - | 1 | - | 1 | - | nCK | 33 |
| Multi Purpose Register Write Recovery Time | tWR_MPR | tMOD (min) + AL + PL | - | tMOD (min) + AL + PL | - | tMOD (min) + AL + PL | - | tMOD (min) + AL + PL | - | tMOD (min) + AL + PL | - | nCK | |
| Auto precharge write recovery + pre-charge time | tDAL(min) | Programmed WR + roundup (tRP / tCK(avg)) | | | | | | | | | | nCK | |
| DQ0 or DQL0 driven to 0 set-up time to first DQS rising edge | tPDA_S | 0.5 | - | 0.5 | - | 0.5 | - | 0.5 | - | 0.5 | - | UI | 45,47 |
| DQ0 or DQL0 driven to 0 hold time from last DQS falling edge | tPDA_H | 0.5 | - | 0.5 | - | 0.5 | - | 0.5 | - | 0.5 | - | UI | 46,47 |
| CS_n to Command Address Latency | | | | | | | | | | | | | |
| CS_n to Command Address Latency | tCAL | max(3 nCK, 3.748 ns) | - | max(3 nCK, 3.748 ns) | - | max(3 nCK, 3.748 ns) | - | max(3 nCK, 3.748 ns) | - | max(3 nCK, 3.748 ns) | - | nCK | |
| Mode Register Set command cycle time in CAL mode | tMRD_tCAL | tMOD+tCAL | - | tMOD+tCAL | - | tMOD+tCAL | - | tMOD+tCAL | - | tMOD+tCAL | - | nCK | |
| Mode Register Set update delay in CAL mode | tMOD_tCAL | tMOD+tCAL | - | tMOD+tCAL | - | tMOD+tCAL | - | tMOD+tCAL | - | tMOD+tCAL | - | nCK | |
| DRAM Data Timing | | | | | | | | | | | | | |
| DQS_t, DQS_c to DQ skew, per group, per access | tDQSQ | - | 0.16 | - | 0.16 | - | 0.16 | - | 0.17 | - | 0.18 | tCK(avg)/2 | 13,18,39,49 |
| DQ output hold time per group, per access from DQS_t, DQS_c | tQH | 0.76 | - | 0.76 | - | 0.76 | - | 0.74 | - | 0.74 | - | tCK(avg)/2 | 13,17,18,39,49 |
| Data Valid Window per device, per UI: (tQH - tDQSQ) of each UI on a given DRAM | tDVWd | 0.63 | - | 0.63 | - | 0.64 | - | 0.64 | - | TBD | - | UI | 17,18,39,49 |
| Data Valid Window, per pin, per UI: (tQH - tDQSQ) each UI on a pin of a given DRAM | tDVWp | 0.66 | - | 0.66 | - | 0.69 | - | 0.72 | - | 0.72 | - | UI | 17,18,39,49 |
| DQ low impedance time from CK_t, CK_c | tLZ(DQ) | -450 | 225 | -390 | 195 | -360 | 180 | -330 | 175 | -310 | 170 | ps | 39 |
| DQ high impedance time from CK_t, CK_c | tHZ(DQ) | - | 225 | - | 195 | - | 180 | - | 175 | - | 170 | ps | 39 |
| Data Strobe Timing | | | | | | | | | | | | | |
| DQS_t, DQS_c differential READ Pre-amble (1 clock preamble) | tRPRE | 0.9 | NOTE44 | 0.9 | NOTE44 | 0.9 | NOTE44 | 0.9 | NOTE 44 | 0.9 | NOTE 44 | tCK | 40 |
| DQS_t, DQS_c differential READ Preamble (2 clock preamble) | tRPRE2 | NA | NA | NA | NA | NA | NA | 1.8 | NOTE 44 | 1.8 | NOTE 44 | tCK | 41 |
| DQS_t, DQS_c differential READ Postamble | tRPST | 0.33 | NOTE 45 | 0.33 | NOTE 45 | 0.33 | NOTE 45 | 0.33 | NOTE 45 | 0.33 | NOTE 45 | tCK | |
| DQS_t, DQS_c differential output high time | tQSH | 0.4 | - | 0.4 | - | 0.4 | - | 0.4 | - | 0.4 | - | tCK | 21 |
| DQS_t, DQS_c differential output low time | tQSL | 0.4 | - | 0.4 | - | 0.4 | - | 0.4 | - | 0.4 | - | tCK | 20 |

[Table 53] Timing Parameters by Speed Bin for DDR4-1600 to DDR4-2666

| Speed | | DDR4-1600 | | DDR4-1866 | | DDR4-2133 | | DDR4-2400 | | DDR4-2666 | | Units | NOTE |
|---|------------------|--------------------------|-----------|--------------------------|-----------|--------------------------|-----------|--------------------------|-----------|--------------------------|-----------|-------|----------|
| Parameter | Symbol | MIN | MAX | MIN | MAX | MIN | MAX | MIN | MAX | MIN | MAX | | |
| DQS_t, DQS_c differential WRITE Preamble (1 clock preamble) | tWPRE | 0.9 | - | 0.9 | - | 0.9 | - | 0.9 | - | 0.9 | - | tCK | 42 |
| DQS_t, DQS_c differential WRITE Preamble (2 clock preamble) | tWPRE2 | NA | - | NA | - | NA | - | 1.8 | - | 1.8 | - | tCK | 43 |
| DQS_t, DQS_c differential WRITE Postamble | tWPST | 0.33 | - | 0.33 | - | 0.33 | - | 0.33 | - | 0.33 | - | tCK | |
| DQS_t and DQS_c low-impedance time (Referenced from RL-1) | tLZ(DQS) | -450 | 225 | -390 | 195 | -360 | 180 | -330 | 175 | -310 | 170 | ps | |
| DQS_t and DQS_c high-impedance time (Referenced from RL+BL/2) | tHZ(DQS) | - | 225 | - | 195 | - | 180 | - | 175 | - | 170 | ps | |
| DQS_t, DQS_c differential input low pulse width | tDQSL | 0.46 | 0.54 | 0.46 | 0.54 | 0.46 | 0.54 | 0.46 | 0.54 | 0.46 | 0.54 | tCK | |
| DQS_t, DQS_c differential input high pulse width | tDQSH | 0.46 | 0.54 | 0.46 | 0.54 | 0.46 | 0.54 | 0.46 | 0.54 | 0.46 | 0.54 | tCK | |
| DQS_t, DQS_c rising edge to CK_t, CK_c rising edge (1 clock preamble) | tDQSS | -0.27 | 0.27 | -0.27 | 0.27 | -0.27 | 0.27 | -0.27 | 0.27 | -0.27 | 0.27 | tCK | 42 |
| DQS_t, DQS_c rising edge to CK_t, CK_c rising edge (2 clock preamble) | tDQSS2 | N/A | N/A | N/A | N/A | N/A | N/A | N/A | N/A | N/A | N/A | tCK | 43 |
| DQS_t, DQS_c falling edge setup time to CK_t, CK_c rising edge | tDSS | 0.18 | - | 0.18 | - | 0.18 | - | 0.18 | - | 0.18 | - | tCK | |
| DQS_t, DQS_c falling edge hold time from CK_t, CK_c rising edge | tDSH | 0.18 | - | 0.18 | - | 0.18 | - | 0.18 | - | 0.18 | - | tCK | |
| DQS_t, DQS_c rising edge output timing location from rising CK_t, CK_c with DLL On mode | tDQSCK (DLL On) | -225 | 225 | -195 | 195 | -180 | 180 | -175 | 175 | -170 | 170 | ps | 37,38,39 |
| DQS_t, DQS_c rising edge output variance window per DRAM | tDQSCKI (DLL On) | - | 370 | - | 330 | - | 310 | - | 290 | - | 270 | ps | 37,38,39 |
| MPSM Timing | | | | | | | | | | | | | |
| Command path disable delay upon MPSM entry | tMPED | tMOD(min)+tCP-DED(min) | - | tMOD(min)+tCP-DED(min) | - | tMOD(min)+tCP-DED(min) | - | tMOD(min)+tCP-DED(min) | - | tMOD(min)+tCP-DED(min) | - | | |
| Valid clock requirement after MPSM entry | tCKMPE | tMOD(min)+tCP-DED(min) | - | tMOD(min)+tCP-DED(min) | - | tMOD(min)+tCP-DED(min) | - | tMOD(min)+tCP-DED(min) | - | tMOD(min)+tCP-DED(min) | - | | |
| Valid clock requirement before MPSM exit | tCKMPX | tCKSRX(min) | - | tCKSRX(min) | - | tCKSRX(min) | - | tCKSRX(min) | - | tCKSRX(min) | - | | |
| Exit MPSM to commands not requiring a locked DLL | tXMP | tXS(min) | - | tXS(min) | - | tXS(min) | - | tXS(min) | - | tXS(min) | - | | |
| Exit MPSM to commands requiring a locked DLL | tXMPDLL | tXMP(min)+tXSDLL(min) | - | tXMP(min)+tXSDLL(min) | - | tXMP(min)+tXSDLL(min) | - | tXMP(min)+tXSDLL(min) | - | tXMP(min)+tXSDLL(min) | - | | |
| CS setup time to CKE | tMPX_S | tIS(min)+tIH(min) | - | tIS(min)+tIH(min) | - | tIS(min)+tIH(min) | - | tIS(min)+tIH(min) | - | tIS(min)+tIH(min) | - | | |
| CS_n High hold time to CKE rising edge | tMPX_HH | tXP(min) | - | tXP(min) | - | tXP(min) | - | tXP(min) | - | tXP(min) | - | | |
| CS_n Low hold time to CKE rising edge | tMPX_LH | 12 | tXMP-10ns | 12 | tXMP-10ns | 12 | tXMP-10ns | 12 | tXMP-10ns | 12 | tXMP-10ns | ns | 51 |
| Calibration Timing | | | | | | | | | | | | | |
| Power-up and RESET calibration time | tZQinit | 1024 | - | 1024 | - | 1024 | - | 1024 | - | 1024 | - | nCK | |
| Normal operation Full calibration time | tZQoper | 512 | - | 512 | - | 512 | - | 512 | - | 512 | - | nCK | |
| Normal operation Short calibration time | tZQCS | 128 | - | 128 | - | 128 | - | 128 | - | 128 | - | nCK | |
| Reset/Self Refresh Timing | | | | | | | | | | | | | |
| Exit Reset from CKE HIGH to a valid command | tXPR | max(5nCK,tRFC(min)+10ns) | - | max(5nCK,tRFC(min)+10ns) | - | max(5nCK,tRFC(min)+10ns) | - | max(5nCK,tRFC(min)+10ns) | - | max(5nCK,tRFC(min)+10ns) | - | nCK | |
| Exit Self Refresh to commands not requiring a locked DLL | tXS | tRFC(min)+10ns | - | tRFC(min)+10ns | - | tRFC(min)+10ns | - | tRFC(min)+10ns | - | tRFC(min)+10ns | - | nCK | |
| SRX to commands not requiring a locked DLL in Self Refresh ABORT | tX-S_ABORT(min) | tRFC4(min)+10ns | - | tRFC4(min)+10ns | - | tRFC4(min)+10ns | - | tRFC4(min)+10ns | - | tRFC4(min)+10ns | - | nCK | |
| Exit Self Refresh to ZQCL,ZQCS and MRS (CL,CWL,WR,RTP and Gear Down) | tXS_FAST(min) | tRFC4(min)+10ns | - | tRFC4(min)+10ns | - | tRFC4(min)+10ns | - | tRFC4(min)+10ns | - | tRFC4(min)+10ns | - | nCK | |
| Exit Self Refresh to commands requiring a locked DLL | tXSDLL | tDLLK(min) | - | tDLLK(min) | - | tDLLK(min) | - | tDLLK(min) | - | tDLLK(min) | - | nCK | |
| Minimum CKE low width for Self refresh entry to exit timing | tCKESR | tCKE(min)+1nCK | - | tCKE(min)+1nCK | - | tCKE(min)+1nCK | - | tCKE(min)+1nCK | - | tCKE(min)+1nCK | - | nCK | |
| Minimum CKE low width for Self refresh entry to exit timing with CA Parity enabled | tCKESR_PAR | tCKE(min)+1nCK+PL | - | tCKE(min)+1nCK+PL | - | tCKE(min)+1nCK+PL | - | tCKE(min)+1nCK+PL | - | tCKE(min)+1nCK+PL | - | nCK | |
| Valid Clock Requirement after Self Refresh Entry (SRE) or Power-Down Entry (PDE) | tCKSRE | max(5nCK,10ns) | - | max(5nCK,10ns) | - | max(5nCK,10ns) | - | max(5nCK,10ns) | - | max(5nCK,10ns) | - | nCK | |

[Table 53] Timing Parameters by Speed Bin for DDR4-1600 to DDR4-2666

| Speed | | DDR4-1600 | | DDR4-1866 | | DDR4-2133 | | DDR4-2400 | | DDR4-2666 | | Units | NOTE |
|--|----------------|----------------------|---------|----------------------|---------|----------------------|---------|----------------------|---------|----------------------|---------|----------|-------|
| Parameter | Symbol | MIN | MAX | MIN | MAX | MIN | MAX | MIN | MAX | MIN | MAX | | |
| Valid Clock Requirement after Self Refresh Entry (SRE) or Power-Down when CA Parity is enabled | tCKSRE_PAR | max (5nCK, 10ns) +PL | - | max (5nCK, 10ns) +PL | - | max (5nCK, 10ns) +PL | - | max (5nCK, 10ns) +PL | - | max (5nCK, 10ns) +PL | - | nCK | |
| Valid Clock Requirement before Self Refresh Exit (SRX) or Power-Down Exit (PDX) or Reset Exit | tCKSRX | max(5nCK, 10ns) | - | max(5nCK, 10ns) | - | max(5nCK, 10ns) | - | max(5nCK, 10ns) | - | max(5nCK, 10ns) | - | nCK | |
| Power Down Timing | | | | | | | | | | | | | |
| Exit Power Down with DLL on to any valid command; Exit Precharge Power Down with DLL frozen to commands not requiring a locked DLL | tXP | max (4nCK, 6ns) | - | max (4nCK, 6ns) | - | max (4nCK, 6ns) | - | max (4nCK, 6ns) | - | max (4nCK, 6ns) | - | nCK | |
| CKE minimum pulse width | tCKE | max (3nCK, 5ns) | - | max (3nCK, 5ns) | - | max (3nCK, 5ns) | - | max (3nCK, 5ns) | - | max (3nCK, 5ns) | - | nCK | 31,32 |
| Command pass disable delay | tCPDED | 4 | - | 4 | - | 4 | - | 4 | - | 4 | - | nCK | |
| Power Down Entry to Exit Timing | tPD | tCKE(min) | 9*tREFI | tCKE(min) | 9*tREFI | tCKE(min) | 9*tREFI | tCKE(min) | 9*tREFI | tCKE(min) | 9*tREFI | nCK | 6 |
| Timing of ACT command to Power Down entry | tACTPDEN | 1 | - | 1 | - | 2 | - | 2 | - | 2 | - | nCK | 7 |
| Timing of PRE or PREA command to Power Down entry | tPRPDEN | 1 | - | 1 | - | 2 | - | 2 | - | 2 | - | nCK | 7 |
| Timing of RD/RDA command to Power Down entry | tRDPDEN | RL+4+1 | - | RL+4+1 | - | RL+4+1 | - | RL+4+1 | - | RL+4+1 | - | nCK | |
| Timing of WR command to Power Down entry (BL80TF, BL8MRS, BC40TF) | tWRPDEN | WL+4+(tWR/tCK(avg)) | - | WL+4+(tWR/tCK(avg)) | - | WL+4+(tWR/tCK(avg)) | - | WL+4+(tWR/tCK(avg)) | - | WL+4+(tWR/tCK(avg)) | - | nCK | 4 |
| Timing of WRA command to Power Down entry (BL80TF, BL8MRS, BC40TF) | tWRAPDEN | WL+4+WR+1 | - | WL+4+WR+1 | - | WL+4+WR+1 | - | WL+4+WR+1 | - | WL+4+WR+1 | - | nCK | 5 |
| Timing of WR command to Power Down entry (BC4MRS) | tWRPBC4DEN | WL+2+(tWR/tCK(avg)) | - | WL+2+(tWR/tCK(avg)) | - | WL+2+(tWR/tCK(avg)) | - | WL+2+(tWR/tCK(avg)) | - | WL+2+(tWR/tCK(avg)) | - | nCK | 4 |
| Timing of WRA command to Power Down entry (BC4MRS) | tWRAPBC4DEN | WL+2+WR+1 | - | WL+2+WR+1 | - | WL+2+WR+1 | - | WL+2+WR+1 | - | WL+2+WR+1 | - | nCK | 5 |
| Timing of REF command to Power Down entry | tREFPDEN | 1 | - | 1 | - | 2 | - | 2 | - | 2 | - | nCK | 7 |
| Timing of MRS command to Power Down entry | tMRSPDEN | tMOD(min) | - | tMOD(min) | - | tMOD(min) | - | tMOD(min) | - | tMOD(min) | - | nCK | |
| PDA Timing | | | | | | | | | | | | | |
| Mode Register Set command cycle time in PDA mode | tMRD_PDA | max(16nCK, 10ns) | - | max(16nCK, 10ns) | - | max(16nCK, 10ns) | - | max(16nCK, 10ns) | - | max(16nCK, 10ns) | - | nCK | |
| Mode Register Set command update delay in PDA mode | tMOD_PDA | tMOD | | tMOD | | tMOD | | tMOD | | tMOD | | | |
| ODT Timing | | | | | | | | | | | | | |
| Asynchronous RTT turn-on delay (Power-Down with DLL frozen) | tAONAS | 1.0 | 9.0 | 1.0 | 9.0 | 1.0 | 9.0 | 1.0 | 9.0 | 1.0 | 9.0 | ns | |
| Asynchronous RTT turn-off delay (Power-Down with DLL frozen) | tAOFAS | 1.0 | 9.0 | 1.0 | 9.0 | 1.0 | 9.0 | 1.0 | 9.0 | 1.0 | 9.0 | ns | |
| RTT dynamic change skew | tADC | 0.3 | 0.7 | 0.3 | 0.7 | 0.3 | 0.7 | 0.3 | 0.7 | 0.28 | 0.72 | tCK(avg) | |
| Write Leveling Timing | | | | | | | | | | | | | |
| First DQS _t /DQS _c rising edge after write leveling mode is programmed | tWLMRD | 40 | - | 40 | - | 40 | - | 40 | - | 40 | - | nCK | 12 |
| DQS _t /DQS _c delay after write leveling mode is programmed | tWLDQSEN | 25 | - | 25 | - | 25 | - | 25 | - | 25 | - | nCK | 12 |
| Write leveling setup time from rising CK _t , CK _c crossing to rising DQS _t /DQS _c crossing | tWLS | 0.13 | - | 0.13 | - | 0.13 | - | 0.13 | - | 0.13 | - | tCK(avg) | |
| Write leveling hold time from rising DQS _t /DQS _c crossing to rising CK _t , CK _c crossing | tWLH | 0.13 | - | 0.13 | - | 0.13 | - | 0.13 | - | 0.13 | - | tCK(avg) | |
| Write leveling output delay | tWLO | 0 | 9.5 | 0 | 9.5 | 0 | 9.5 | 0 | 9.5 | 0 | 9.5 | ns | |
| Write leveling output error | tWLOE | 0 | 2 | 0 | 2 | 0 | 2 | 0 | 2 | 0 | 2 | ns | |
| CA Parity Timing | | | | | | | | | | | | | |
| Commands not guaranteed to be executed during this time | tPAR_UNKNOWN | - | PL | - | PL | - | PL | - | PL | - | PL | | |
| Delay from errant command to ALERT _n assertion | tPAR_ALERT_ON | - | PL+6ns | - | PL+6ns | - | PL+6ns | - | PL+6ns | - | PL+6ns | | |
| Pulse width of ALERT _n signal when asserted | tPAR_ALERT_PW | 48 | 96 | 56 | 112 | 64 | 128 | 72 | 144 | 80 | 160 | nCK | |
| Time from when Alert is asserted till controller must start providing DES commands in Persistent CA parity mode | tPAR_ALERT_RSP | - | 43 | - | 50 | - | 57 | - | 64 | - | 71 | nCK | |
| Parity Latency | PL | 4 | | 4 | | 4 | | 5 | | 5 | | nCK | |
| CRC Error Reporting | | | | | | | | | | | | | |
| CRC error to ALERT _n latency | tCRC_ALERT | 3 | 13 | 3 | 13 | 3 | 13 | 3 | 13 | 3 | 13 | ns | |
| CRC ALERT _n pulse width | CRC_ALERT_PW | 6 | 10 | 6 | 10 | 6 | 10 | 6 | 10 | 6 | 10 | nCK | |

[Table 53] Timing Parameters by Speed Bin for DDR4-1600 to DDR4-2666

| Speed | | DDR4-1600 | | DDR4-1866 | | DDR4-2133 | | DDR4-2400 | | DDR4-2666 | | Units | NOTE |
|---|-------------|-----------|-----|-----------|-----|-----------|-----|-----------|-----|-------------|-----|-------|------|
| Parameter | Symbol | MIN | MAX | MIN | MAX | MIN | MAX | MIN | MAX | MIN | MAX | | |
| Geardown timing | | | | | | | | | | | | | |
| Exit RESET from CKE HIGH to a valid MRS geardown (T2/Reset) | tXPR_GEAR | - | - | - | - | - | - | - | - | tXPR | - | | |
| CKE High Assert to Gear Down Enable time(T2/CKE) | tXS_GEAR | - | - | - | - | - | - | - | - | tXS | - | | |
| MRS command to Sync pulse time(T3) | tSYNC_GEAR | - | - | - | - | - | - | - | - | tMOD + 4tCK | - | | 27 |
| Sync pulse to First valid command(T4) | tCMD_GEAR | - | - | - | - | - | - | - | - | tMOD | - | | 27 |
| Geardown setup time | tGEAR_setup | - | - | - | - | - | - | - | - | 2 | - | nCK | |
| Geardown hold time | tGEAR_hold | - | - | - | - | - | - | - | - | 2 | - | nCK | |
| tREFI | | | | | | | | | | | | | |
| tRFC1 (min) | 2Gb | 160 | - | 160 | - | 160 | - | 160 | - | 160 | - | ns | 34 |
| | 4Gb | 260 | - | 260 | - | 260 | - | 260 | - | 260 | - | ns | 34 |
| | 8Gb | 350 | - | 350 | - | 350 | - | 350 | - | 350 | - | ns | 34 |
| | 16Gb | 550 | - | 550 | - | 550 | - | 550 | - | 550 | - | ns | 34 |
| tRFC2 (min) | 2Gb | 110 | - | 110 | - | 110 | - | 110 | - | 110 | - | ns | 34 |
| | 4Gb | 160 | - | 160 | - | 160 | - | 160 | - | 160 | - | ns | 34 |
| | 8Gb | 260 | - | 260 | - | 260 | - | 260 | - | 260 | - | ns | 34 |
| | 16Gb | 350 | - | 350 | - | 350 | - | 350 | - | 350 | - | ns | 34 |
| tRFC4 (min) | 2Gb | 90 | - | 90 | - | 90 | - | 90 | - | 90 | - | ns | 34 |
| | 4Gb | 110 | - | 110 | - | 110 | - | 110 | - | 110 | - | ns | 34 |
| | 8Gb | 160 | - | 160 | - | 160 | - | 160 | - | 160 | - | ns | 34 |
| | 16Gb | 260 | - | 260 | - | 260 | - | 260 | - | 260 | - | ns | 34 |

NOTE :

- 1) Start of internal write transaction is defined as follows :
 - For BL8 (Fixed by MRS and on-the-fly) : Rising clock edge 4 clock cycles after WL.
 - For BC4 (on-the-fly) : Rising clock edge 4 clock cycles after WL.
 - For BC4 (fixed by MRS) : Rising clock edge 2 clock cycles after WL.
- 2) A separate timing parameter will cover the delay from write to read when CRC and DM are simultaneously enabled
- 3) Commands requiring a locked DLL are: READ (and RAP) and synchronous ODT commands.
- 4) tWR is defined in ns, for calculation of tWRPDEN it is necessary to round up tWR/tCK following rounding algorithm defined in "17.1 Rounding Algorithms".
- 5) WR in clock cycles as programmed in MR0.
- 6) tREFI depends on TOPER.
- 7) CKE is allowed to be registered low while operations such as row activation, precharge, autoprecharge or refresh are in progress, but power-down IDD spec will not be applied until finishing those operations.
- 8) For these parameters, the DDR4 SDRAM device supports tnPARAM[nCK]=RU{tPARAM[ns]/tCK(avg)[ns]}, which is in clock cycles assuming all input clock jitter specifications are satisfied.
- 9) When CRC and DM are both enabled, tWR_CRC_DM is used in place of tWR.
- 10) When CRC and DM are both enabled tWTR_S_CRC_DM is used in place of tWTR_S.
- 11) When CRC and DM are both enabled tWTR_L_CRC_DM is used in place of tWTR_L.
- 12) The max values are system dependent.
- 13) DQ to DQS total timing per group where the total includes the sum of deterministic and random timing terms for a specified BER. BER spec and measurement method are tbd.
- 14) The deterministic component of the total timing. Measurement method tbd.
- 15) DQ to DQ static offset relative to strobe per group. Measurement method tbd.
- 16) This parameter will be characterized and guaranteed by design.
- 17) When the device is operated with the input clock jitter, this parameter needs to be derated by the actual tjit(per)_total of the input clock. (output deratings are relative to the SDRAM input clock). Example tbd.
- 18) DRAM DBI mode is off.
- 19) DRAM DBI mode is enabled. Applicable to x8 and x16 DRAM only.
- 20) tQSL describes the instantaneous differential output low pulse width on DQS_t - DQS_c, as measured from on falling edge to the next consecutive rising edge
- 21) tQSH describes the instantaneous differential output high pulse width on DQS_t - DQS_c, as measured from on falling edge to the next consecutive rising edge
- 22) There is no maximum cycle time limit besides the need to satisfy the refresh interval tREFI
- 23) tCH(abs) is the absolute instantaneous clock high pulse width, as measured from one rising edge to the following falling edge
- 24) tCL(abs) is the absolute instantaneous clock low pulse width, as measured from one falling edge to the following rising edge
- 25) Total jitter includes the sum of deterministic and random jitter terms for a specified BER. BER target and measurement method are tbd.
- 26) The deterministic jitter component out of the total jitter. This parameter is characterized and guaranteed by design.
- 27) This parameter has to be even number of clocks
- 28) When CRC and DM are both enabled, tWR_CRC_DM is used in place of tWR.
- 29) When CRC and DM are both enabled tWTR_S_CRC_DM is used in place of tWTR_S.
- 30) When CRC and DM are both enabled tWTR_L_CRC_DM is used in place of tWTR_L.
- 31) After CKE is registered LOW, CKE signal level shall be maintained below VILDC for tCKE specification (Low pulse width).
- 32) After CKE is registered HIGH, CKE signal level shall be maintained above VIHDC for tCKE specification (HIGH pulse width).
- 33) Defined between end of MPR read burst and MRS which reloads MPR or disables MPR function.
- 34) Parameters apply from tCK(avg)min to tCK(avg)max at all standard JEDEC clock period values as stated in the Speed Bin Tables.
- 35) This parameter must keep consistency with Speed-Bin Tables shown in section 10.
- 36) DDR4-1600 AC timing apply if DRAM operates at lower than 1600 MT/s data rate. $UI=tCK(avg).min/2$.
- 37) applied when DRAM is in DLL ON mode.
- 38) Assume no jitter on input clock signals to the DRAM.
- 39) Value is only valid for RONNOM = 34 ohms.
- 40) 1tCK toggle mode with setting MR4:A11 to 0.
- 41) 2tCK toggle mode with setting MR4:A11 to 1, which is valid for DDR4-2400 and 2666 speed grade.
- 42) 1tCK mode with setting MR4:A12 to 0.
- 43) 2tCK mode with setting MR4:A12 to 1, which is valid for DDR4-2400 and 2666 speed grade.
- 44) The maximum read preamble is bounded by tLZ(DQS)min on the left side and tDQSCK(max) on the right side. See Figure "Clock to Data Strobe Relationship" in Operation datasheet. Boundary of DQS Low-Z occur one cycle earlier in 2tCK toggle mode which is illustrated in "Read Preamble" section.
- 45) DQ falling signal middle-point of transferring from High to Low to first rising edge of DQS diff-signal cross-point
- 46) last falling edge of DQS diff-signal cross-point to DQ rising signal middle-point of transferring from Low to High
- 47) VrefDQ value must be set to either its midpoint or Vcent_DQ(midpoint) in order to capture DQ0 or DQL0 low level for entering PDA mode.
- 48) The maximum read postamble is bound by tDQSCK(min) plus tQSH(min) on the left side and tHZ(DQS)max on the right side. See Figure "Clock to Data Strobe Relationship" in Operation datasheet.
- 49) Reference level of DQ output signal is specified with a midpoint as a widest part of Output signal eye which should be approximately $0.7 * VDDQ$ as a center level of the static single-ended output peak-to-peak swing with a driver impedance of 34 ohms and an effective test load of 50 ohms to VTT = VDDQ.
- 50) For MR7 commands, the minimum delay to a subsequent non-MRS command is 5nCK.
- 51) tMPX_LH(max) is defined with respect to actual tXMP in system as opposed to tXMP(min).

17.1 Rounding Algorithms

Software algorithms for calculation of timing parameters are subject to rounding errors from many sources. For example, a system may use a memory clock with a nominal frequency of 933.33... MHz, or a clock period of 1.0714... ns. Similarly, a system with a memory clock frequency of 1066.66... MHz yields mathematically a clock period of 0.9375... ns. In most cases, it is impossible to express all digits after the decimal point exactly, and rounding must be done because the DDR4 SDRAM specification establishes a minimum granularity for timing parameters of 1 ps.

Rules for rounding must be defined to allow optimization of device performance without violating device parameters. These algorithms rely on results that are within correction factors on device testing and specification to avoid losing performance due to rounding errors.

These rules are:

- Clock periods such as tCKAVGmin are defined to 1 ps of accuracy; for example, 0.9375... ns is defined as 937 ps and 1.0714... ns is defined as 1071 ps.
- Using real math, parameters like tAAmin, tRCDmin, etc. which are programmed in systems in numbers of clocks (nCK) but expressed in units of time (in ns) are divided by the clock period (in ns) yielding a unitless ratio, a correction factor of 2.5% is subtracted, then the result is set to the next higher integer number of clocks:

$$nCK = \text{ceiling} [(parameter_in_ns / application_tCK_in_ns) - 0.025]$$

- Alternatively, programmers may prefer to use integer math instead of real math by expressing timing in ps, scaling the desired parameter value by 1000, dividing by the application clock period, adding an inverse correction factor of 97.4%, dividing the result by 1000, then truncating down to the next lower integer value:

$$nCK = \text{truncate} [((parameter_in_ps \times 1000) / (application_tCK_in_ps) + 974) / 1000]$$

- Either algorithm yields identical results

17.2 The DQ input receiver compliance mask for voltage and timing

The DQ input receiver compliance mask for voltage and timing is shown in the figure below. The receiver mask (Rx Mask) defines area the input signal must not encroach in order for the DRAM input receiver to be expected to be able to successfully capture a valid input signal with BER of 1e-16; any input signal encroaching within the Rx Mask is subject to being invalid data. The Rx Mask is the receiver property for each DQ input pin and it is not the valid data-eye.

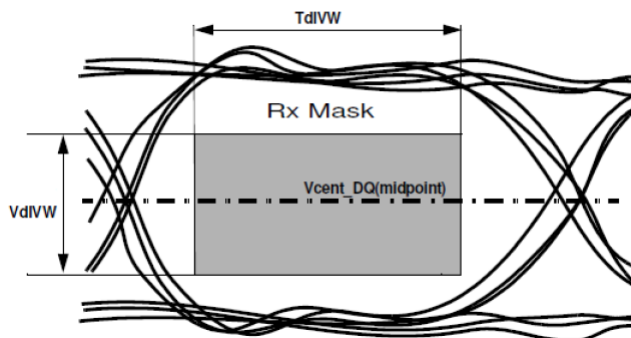

Figure 24. DQ Receiver(Rx) compliance mask

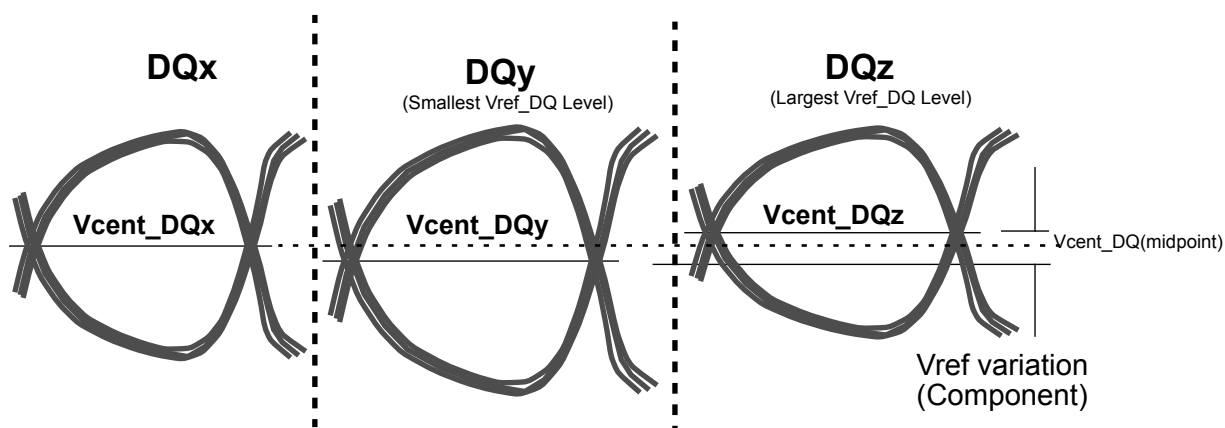
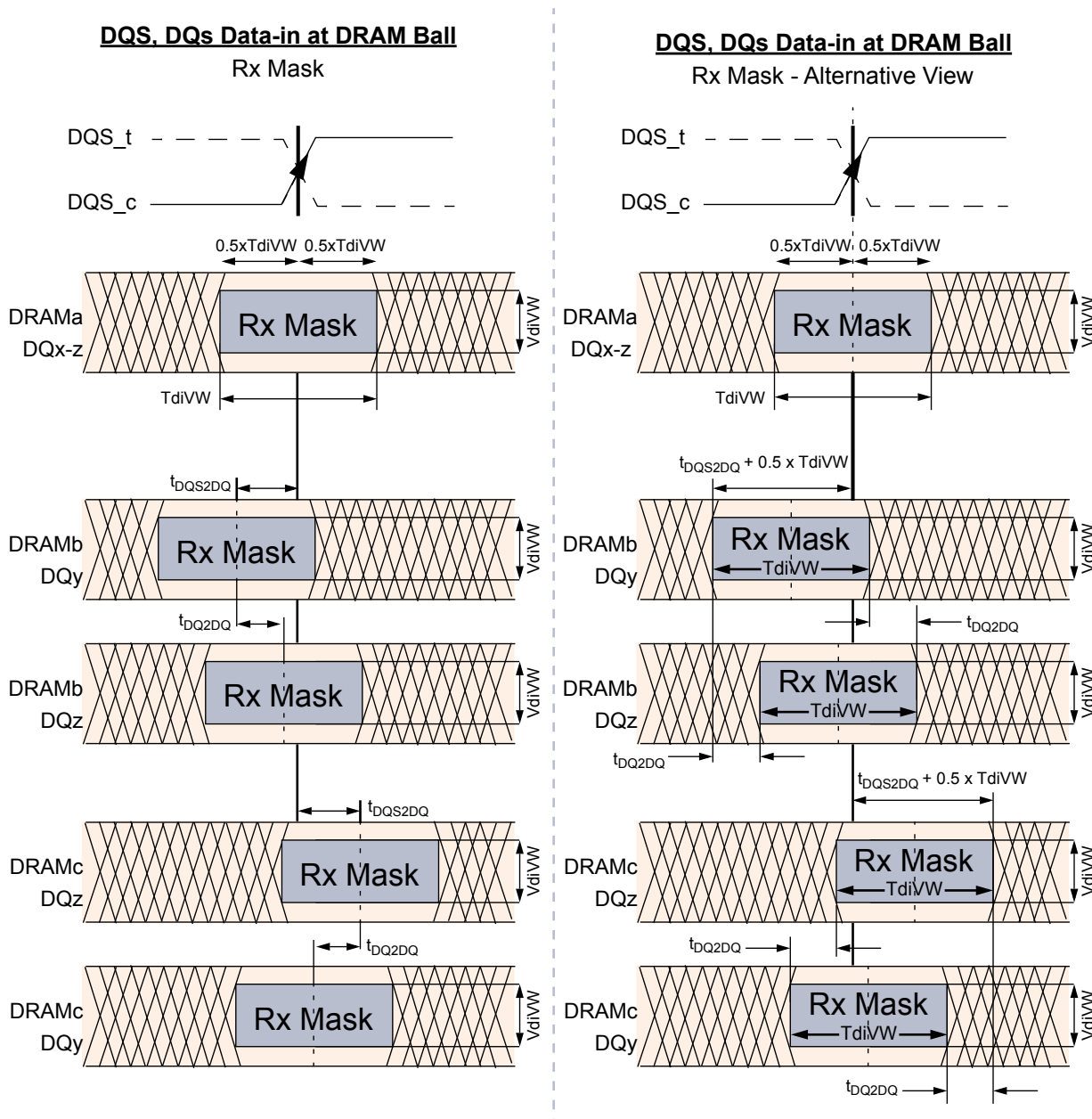

Figure 25. Vcent_DQ Variation to Vcent_DQ(midpoint)

The Vref_DQ voltage is an internal reference voltage level that shall be set to the properly trained setting, which is generally Vcent_DQ(midpoint), in order to have valid Rx Mask values.

Vcent_DQ is defined as the midpoint between the largest Vref_DQ voltage level and the smallest Vref_DQ voltage level across all DQ pins for a given DDR4 DRAM component. Each DQ pin Vref level is defined by the center, i.e. widest opening, of the cumulative data input eye as depicted in Figure 25. This clarifies that any DDR4 DRAM component level variation must be accounted for within the DDR4 DRAM Rx mask. The component level Vref will be set by the system to account for Ron and ODT settings.



NOTE : DQx represents an optimally centered mask.
 DQy represents earliest valid mask.
 DQz represents latest valid mask.

NOTE : DRAMa represents a DRAM without any DQS/DQ skews.
 DRAMB represents a DRAM with early skews (negative t_{DQS2DQ}).
 DRAMc represents a DRAM with delayed skews (positive t_{DQS2DQ}).

NOTE : Figures show skew allowed between DRAM to DRAM and DQ to DQ for a DRAM. Signals assume data centered aligned at DRAM Latch.
 TdiPW is not shown; composite data-eyes shown would violate TdiPW.
 VCENT DQ(midpoint) is not shown but is assumed to be midpoint of VdiVW..

Figure 26. DQS to DQ and DQ to DQ Timings at DRAM Balls

All of the timing terms in Figure 26 are measured at the VdiVW voltage levels centered around Vcent_DQ and are referenced to the DQS_t/DQS_c center aligned to the DQ per pin.

The rising edge slew rates are defined by srr1 and srr2. The slew rate measurement points for a rising edge are shown in Figure 27 below: A low to high transition tr1 is measured from 0.5*VdiVW(max) below Vcent_DQ(midpoint) to the last transition through 0.5*VdiVW(max) above Vcent_DQ(midpoint) while tr2 is measured from the last transition through 0.5*VdiVW(max) above Vcent_DQ(midpoint) to the first transition through the 0.5*VIHL_AC(min) above Vcent_DQ(midpoint).

Rising edge slew rate equations:

$$srr1 = VdiVW(max) / tr1$$

$$srr2 = (VIHL_AC(min) - VdiVW(max)) / (2*tr2)$$

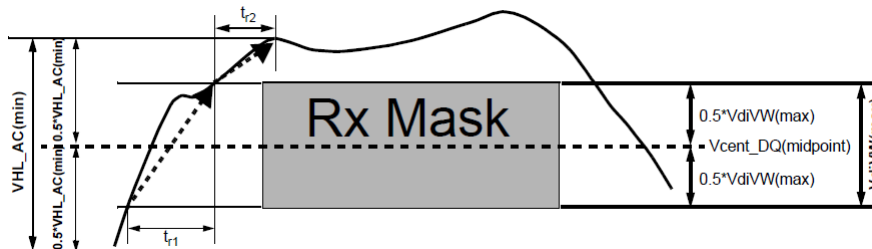

Figure 27. Slew Rate Conditions For Rising Transition

The falling edge slew rates are defined by srf1 and srf2. The slew rate measurement points for a falling edge are shown in Figure 28 below: A high to low transition tf1 is measured from 0.5*VdiVW(max) above Vcent_DQ(midpoint) to the last transition through 0.5*VdiVW(max) below Vcent_DQ(midpoint) while tf2 is measured from the last transition through 0.5*VdiVW(max) below Vcent_DQ(midpoint) to the first transition through the 0.5*VIHL_AC(min) below Vcent_DQ(pin mid).

Falling edge slew rate equations:

$$srf1 = VdiVW(max) / tf1$$

$$srf2 = (VIHL_AC(min) - VdiVW(max)) / (2*tf2)$$

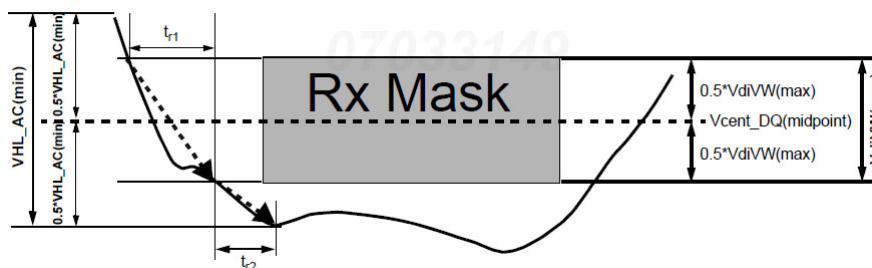

Figure 28. Slew Rate Conditions For Falling Transition

[Table 54] DRAM DQs In Receive Mode;

| Symbol | Parameter | 1600/1866/2133 | | 2400 | | 2666 | | Unit | NOTE |
|------------|--|----------------|------|----------|------|----------|-------|------|--------|
| | | min | max | min | max | min | max | | |
| VdIVW | Rx Mask voltage - pk-pk | - | 136 | - | 130 | - | 120 | mV | 1,2,10 |
| TdIVW | Rx timing window | - | 0.2 | - | 0.2 | - | 0.22 | UI* | 1,2,10 |
| VIHL_AC | DQ AC input swing pk-pk | 186 | - | 160 | - | 150 | - | mV | 3,4,10 |
| TdIPW | DQ input pulse width | 0.58 | - | 0.58 | - | 0.58 | - | UI* | 5,10 |
| tDQS2DQ | Rx Mask DQS to DQ offset | -0.17 | 0.17 | -0.17 | 0.17 | -0.19 | 0.19 | UI* | 6, 10 |
| tDQ2DQ | Rx Mask DQ to DQ offset | - | TBD | - | TBD | - | 0.105 | UI* | 7 |
| srr1, srf1 | Input Slew Rate over VdIVW if tCK > 0.937ns | 1.0 | 9 | 1.0 | 9 | 1.0 | 9 | V/ns | 8,10 |
| | Input Slew Rate over VdIVW if 0.937ns > tCK >= 0.625ns | - | - | 1.25 | 9 | 1.25 | 9 | V/ns | 8,10 |
| srr2 | Rising Input Slew Rate over 1/2 VIHL_AC | 0.2*srr1 | 9 | 0.2*srr1 | 9 | 0.2*srr1 | 9 | V/ns | 9,10 |
| srf2 | Falling Input Slew Rate over 1/2 VIHL_AC | 0.2*srf1 | 9 | 0.2*srf1 | 9 | 0.2*srf1 | 9 | V/ns | 9,10 |

* UI=tck(avg)min/2

NOTE :

- 1) Data Rx mask voltage and timing total input valid window where VdIVW is centered around Vcent_DQ(midpoint) after VrefDQ training is completed. The data Rx mask is applied per bit and should include voltage and temperature drift terms. The input buffer design specification is to achieve at least a BER = e-16 when the RxMask is not violated. The BER will be characterized and extrapolated if necessary using a dual dirac method from a higher BER(tbd).
- 2) Defined over the DQ internal Vref range 1.
- 3) See Overshoot and Undershoot Specifications.
- 4) DQ input pulse signal swing into the receiver must meet or exceed VIHL AC(min). VIHL_AC(min) is to be achieved on an UI basis when a rising and falling edge occur in the same UI, i.e. a valid TdiPW.
- 5) DQ minimum input pulse width defined at the Vcent_DQ(midpoint).
- 6) DQS to DQ offset is skew between DQS and DQs within a nibble (x4) or word (x8, x16) at the DDR4 SDRAM balls over process, voltage, and temperature.
- 7) DQ to DQ offset is skew between DQs within a nibble (x4) or word (x8, x16) at the DDR4 SDRAM balls for a given component over process, voltage, and temperature.
- 8) Input slew rate over VdIVW Mask centered at Vcent_DQ(midpoint). Slowest DQ slew rate to fastest DQ slew rate per transition edge must be within 1.7 V/ns of each other.
- 9) Input slew rate between VdIVW Mask edge and VIHL_AC(min) points.
- 10) All Rx Mask specifications must be satisfied for each UI. For example, if the minimum input pulse width is violated when satisfying TdiVW(min), VdiVW(max), and minimum slew rate limits, then either TdiVW(min) or minimum slew rates would have to be increased to the point where the minimum input pulse width would no longer be violated.

17.3 Command, Control, and Address Setup, Hold, and Derating

The total tIS (setup time) and tIH (hold time) required is calculated to account for slew rate variation by adding the data sheet tIS (base) values, the VIL(AC)/VIH(AC) points, and tIH (base) values, the VIL(DC)/VIH(DC) points; to the ΔtIS and ΔtIH derating values, respectively. The base values are derived with single-end signals at 1V/ns and differential clock at 2V/ns. Example: tIS (total setup time) = tIS (base) + ΔtIS .

For a valid transition, the input signal has to remain above/below VIH(AC)/VIL(AC) for the time defined by tVAC.

Although the total setup time for slow slew rates might be negative (for example, a valid input signal will not have reached VIH(AC)/VIL(AC) at the time of the rising clock transition), a valid input signal is still required to complete the transition and to reach VIH(AC)/VIL(AC). For slew rates that fall between the values listed in derating tables, the derating values may be obtained by linear interpolation.

Setup (tIS) nominal slew rate for a rising signal is defined as the slew rate between the last crossing of VIL(DC)max and the first crossing of VIH(AC)min that does not ring back below VIH(DC)min. Setup (tIS) nominal slew rate for a falling signal is defined as the slew rate between the last crossing of VIH(DC)min and the first crossing of VIL(AC)max that does not ring back above VIL(DC)max. Hold (tIH) nominal slew rate for a rising signal is defined as the slew rate between the last crossing of VIL(DC)max and the first crossing of VIH(AC)min that does not ring back below VIH(DC)min. Hold (tIH) nominal slew rate for a falling signal is defined as the slew rate between the last crossing of VIH(DC)min and the first crossing of VIL(AC)min that does not ring back above VIL(DC)max.

[Table 55] Command, Address, Control Setup and Hold Values

| DDR4 | 1600 | 1866 | 2133 | 2400 | 2666 | Unit | Reference |
|------------------|------|------|------|------|------|------|-----------|
| tIS(base, AC100) | 115 | 100 | 80 | 62 | - | ps | VIH/L(ac) |
| tIH(base, DC75) | 140 | 125 | 105 | 87 | - | ps | VIH/L(dc) |
| tIS(base, AC 90) | - | - | - | - | 55 | ps | VIH/L(ac) |
| tIH(base, DC 65) | - | - | - | - | 80 | ps | VIH/L(dc) |
| tIS/tIH @ VREF | 215 | 200 | 180 | 162 | 145 | ps | |

NOTE :

- 1) Base ac/dc referenced for 1V/ns slew rate and 2 V/ns clock slew rate.
- 2) Values listed are referenced only; applicable limits are defined elsewhere.

[Table 56] Command, Address, Control Input Voltage Values

| DDR4 | 1600 | 1866 | 2133 | 2400 | 2666 | Unit | Reference |
|---------------|------|------|------|------|------|------|-----------|
| VIH.CA(AC)min | 100 | 100 | 100 | 100 | 90 | mV | VIH/L(ac) |
| VIH.CA(DC)min | 75 | 75 | 75 | 75 | 65 | mV | VIH/L(dc) |
| VIL.CA(DC)max | -75 | -75 | -75 | -75 | -65 | mV | VIH/L(dc) |
| VIL.CA(AC)max | -100 | -100 | -100 | -100 | -90 | mV | VIH/L(ac) |

NOTE :

- 1) Command, Address, Control input levels relative to VREFCA.
- 2) Values listed are referenced only; applicable limits are defined elsewhere.

[Table 57] Derating values DDR4-1600/1866/2133/2400 tIS/tIH - ac/dc based

| ΔtIS, ΔtIH derating in [ps] AC/DC based ¹⁾ | | | | | | | | | | | | | | | | | |
|--|------|-----------------------------------|------|-------|------|-------|------|-------|------|---------|------|---------|------|---------|------|-------|------|
| | | CK_t, CK_c Differential Slew Rate | | | | | | | | | | | | | | | |
| | | 10V/ns | | 8V/ns | | 6V/ns | | 4V/ns | | 3.0V/ns | | 2.0V/ns | | 1.5V/ns | | 1V/ns | |
| | | ΔtIS | ΔtIH | ΔtIS | ΔtIH | ΔtIS | ΔtIH | ΔtIS | ΔtIH | ΔtIS | ΔtIH | ΔtIS | ΔtIH | ΔtIS | ΔtIH | ΔtIS | ΔtIH |
| CMD, ADDR, CNTL Input Slew rate V/ns | 7 | 76 | 54 | 76 | 55 | 77 | 56 | 79 | 58 | 82 | 60 | 86 | 64 | 94 | 73 | 111 | 89 |
| | 6 | 73 | 53 | 74 | 53 | 75 | 54 | 77 | 56 | 79 | 58 | 83 | 63 | 92 | 71 | 108 | 88 |
| | 5 | 70 | 50 | 71 | 51 | 72 | 52 | 74 | 54 | 76 | 56 | 80 | 60 | 88 | 68 | 105 | 85 |
| | 4 | 65 | 46 | 66 | 47 | 67 | 48 | 69 | 50 | 71 | 52 | 75 | 56 | 83 | 65 | 100 | 81 |
| | 3 | 57 | 40 | 57 | 41 | 58 | 42 | 60 | 44 | 63 | 46 | 67 | 50 | 75 | 58 | 92 | 75 |
| | 2 | 40 | 28 | 41 | 28 | 42 | 29 | 44 | 31 | 46 | 33 | 50 | 38 | 58 | 46 | 75 | 63 |
| | 1.5 | 23 | 15 | 24 | 16 | 25 | 17 | 27 | 19 | 29 | 21 | 33 | 25 | 42 | 33 | 58 | 50 |
| | 1 | -10 | -10 | -9 | -9 | -8 | -8 | -6 | -6 | -4 | -4 | 0 | 0 | 8 | 8 | 25 | 25 |
| | 0.9 | -17 | -14 | -16 | -14 | -15 | -13 | -13 | -10 | -11 | -8 | -7 | -4 | 1 | 4 | 18 | 21 |
| | 0.8 | -26 | -19 | -25 | -19 | -24 | -18 | -22 | -16 | -20 | -14 | -16 | -9 | -7 | -1 | 9 | 16 |
| | 0.7 | -37 | -26 | -36 | -25 | -35 | -24 | -33 | -22 | -31 | -20 | -27 | -16 | -18 | -8 | -2 | 9 |
| | 0.6 | -52 | -35 | -51 | -34 | -50 | -33 | -48 | -31 | -46 | -29 | -42 | -25 | -33 | -17 | -17 | 0 |
| | 0.5 | -73 | -48 | -72 | -47 | -71 | -46 | -69 | -44 | -67 | -42 | -63 | -38 | -54 | -29 | -38 | -13 |
| 0.4 | -104 | -66 | -103 | -66 | -102 | -65 | -100 | -63 | -98 | -60 | -94 | -56 | -85 | -48 | -69 | -31 | |

NOTE :
1) VIH/L(ac) = +/-100mV, VIH/L(dc) = +/-75mV; relative to VREFCA.

[Table 58] Derating values DDR4-2666 tIS/tIH - ac/dc based

| ΔtIS, ΔtIH derating in [ps] AC/DC based ¹⁾ | | | | | | | | | | | | | | | | | |
|--|-----|-----------------------------------|------|-------|------|-------|------|-------|------|---------|------|---------|------|---------|------|-------|------|
| | | CK_t, CK_c Differential Slew Rate | | | | | | | | | | | | | | | |
| | | 10V/ns | | 8V/ns | | 6V/ns | | 4V/ns | | 3.0V/ns | | 2.0V/ns | | 1.5V/ns | | 1V/ns | |
| | | ΔtIS | ΔtIH | ΔtIS | ΔtIH | ΔtIS | ΔtIH | ΔtIS | ΔtIH | ΔtIS | ΔtIH | ΔtIS | ΔtIH | ΔtIS | ΔtIH | ΔtIS | ΔtIH |
| CMD, ADDR, CNTL Input Slew rate V/ns | 7 | TBD | TBD | TBD | TBD | TBD | TBD | TBD | TBD | TBD | TBD | TBD | TBD | TBD | TBD | TBD | TBD |
| | 6 | TBD | TBD | TBD | TBD | TBD | TBD | TBD | TBD | TBD | TBD | TBD | TBD | TBD | TBD | TBD | TBD |
| | 5 | TBD | TBD | TBD | TBD | TBD | TBD | TBD | TBD | TBD | TBD | TBD | TBD | TBD | TBD | TBD | TBD |
| | 4 | TBD | TBD | TBD | TBD | TBD | TBD | TBD | TBD | TBD | TBD | TBD | TBD | TBD | TBD | TBD | TBD |
| | 3 | TBD | TBD | TBD | TBD | TBD | TBD | TBD | TBD | TBD | TBD | TBD | TBD | TBD | TBD | TBD | TBD |
| | 2 | TBD | TBD | TBD | TBD | TBD | TBD | TBD | TBD | TBD | TBD | TBD | TBD | TBD | TBD | TBD | TBD |
| | 1.5 | TBD | TBD | TBD | TBD | TBD | TBD | TBD | TBD | TBD | TBD | TBD | TBD | TBD | TBD | TBD | TBD |
| | 1 | TBD | TBD | TBD | TBD | TBD | TBD | TBD | TBD | TBD | TBD | TBD | TBD | TBD | TBD | TBD | TBD |
| | 0.9 | TBD | TBD | TBD | TBD | TBD | TBD | TBD | TBD | TBD | TBD | TBD | TBD | TBD | TBD | TBD | TBD |
| | 0.8 | TBD | TBD | TBD | TBD | TBD | TBD | TBD | TBD | TBD | TBD | TBD | TBD | TBD | TBD | TBD | TBD |
| | 0.7 | TBD | TBD | TBD | TBD | TBD | TBD | TBD | TBD | TBD | TBD | TBD | TBD | TBD | TBD | TBD | TBD |
| | 0.6 | TBD | TBD | TBD | TBD | TBD | TBD | TBD | TBD | TBD | TBD | TBD | TBD | TBD | TBD | TBD | TBD |
| | 0.5 | TBD | TBD | TBD | TBD | TBD | TBD | TBD | TBD | TBD | TBD | TBD | TBD | TBD | TBD | TBD | TBD |
| 0.4 | TBD | TBD | TBD | TBD | TBD | TBD | TBD | TBD | TBD | TBD | TBD | TBD | TBD | TBD | TBD | TBD | |

NOTE :
1) VIH/L(ac) = +/-tbd mV, VIH/L(dc) = +/- tbd mV; relative to VREFCA

17.4 DDR4 Function Matrix

DDR4 SDRAM has several features supported by ORG and also by Speed. The following Table is the summary of the features.

[Table 59] Function Matrix (By ORG. V:Supported, Blank:Not supported)

| Functions | x4 | x8 | NOTE |
|--------------------------------|----|----|------|
| Write Leveling | V | V | |
| Temperature controlled Refresh | V | V | |
| Low Power Auto Self Refresh | V | V | |
| Fine Granularity Refresh | V | V | |
| Multi Purpose Register | V | V | |
| Data Mask | | V | |
| Data Bus Inversion | | V | |
| TDQS | | V | |
| ZQ calibration | V | V | |
| DQ Vref Training | V | V | |
| Per DRAM Addressability | V | V | |
| Mode Register Readout | V | V | |
| CAL | V | V | |
| WRITE CRC | V | V | |
| CA Parity | V | V | |
| Control Gear Down Mode | V | V | |
| Programmable Preamble | V | V | |
| Maximum Power Down Mode | V | V | |
| Boundary Scan Mode | | | |
| Additive Latency | V | V | |
| 3DS | V | V | |

[Table 60] Function Matrix (By Speed. V:Supported, Blank:Not supported)

| Functions | DLL Off mode | DLL On mode | | | NOTE |
|--------------------------------|------------------------------|---------------------|----------|----------|------|
| | equal or slower than 250Mbps | 1600/1866/2133 Mbps | 2400Mbps | 2666Mbps | |
| Write Leveling | V | V | V | V | |
| Temperature controlled Refresh | V | V | V | V | |
| Low Power Auto Self Refresh | V | V | V | V | |
| Fine Granularity Refresh | V | V | V | V | |
| Multi Purpose Register | V | V | V | V | |
| Data Mask | V | V | V | V | |
| Data Bus Inversion | V | V | V | V | |
| TDQS | | V | V | V | |
| ZQ calibration | V | V | V | V | |
| DQ Vref Training | V | V | V | V | |
| Per DRAM Addressability | | V | V | V | |
| Mode Register Readout | V | V | V | V | |
| CAL | | V | V | V | |
| WRITE CRC | | V | V | V | |
| CA Parity | | V | V | V | |
| Control Gear Down Mode | | | | V | |
| Programmable Preamble (= 2tCK) | | | V | V | |
| Maximum Power Down Mode | | V | V | V | |
| Boundary Scan Mode | V | V | V | V | |
| 3DS | V | V | V | V | |

18. PHYSICAL DIMENSIONS

18.1 512Mbx16 based 512Mx64 Module (1 Rank) - M378A5244BB0

Units : Millimeters

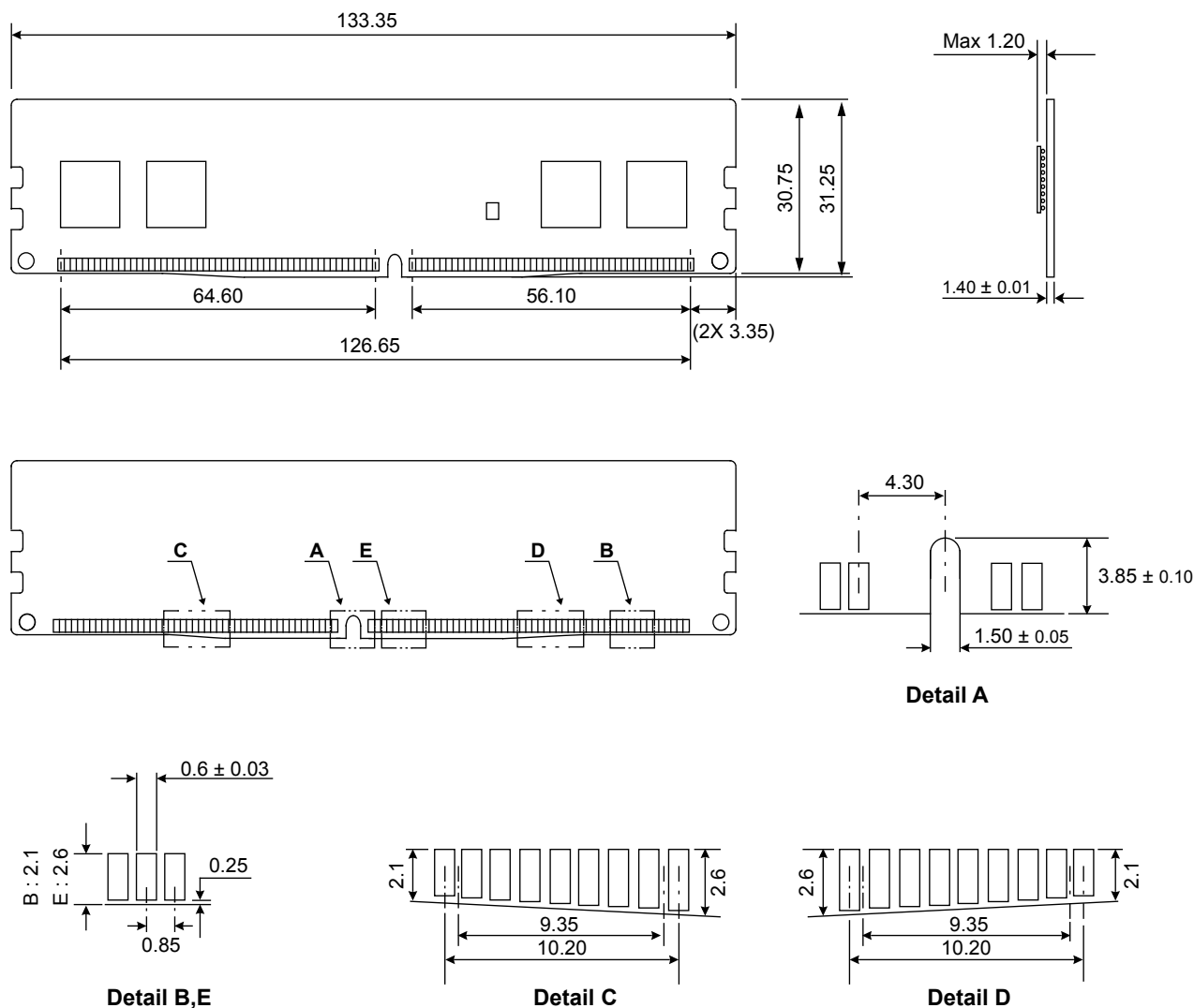

The used device is 512M x16 DDR4 SDRAM, FBGA.
 DDR4 SDRAM Part NO : K4A8G165WB-BC**

NOTE :

1) Tolerances on all dimensions ±0.15 unless otherwise specified.

18.2 1Gx8 based 1Gx64 Module (1 Rank) - M378A1K43BB1

Units : Millimeters

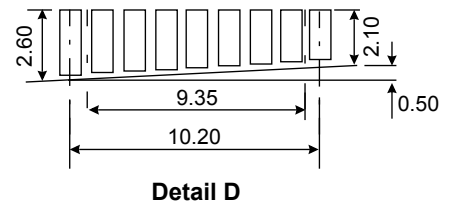
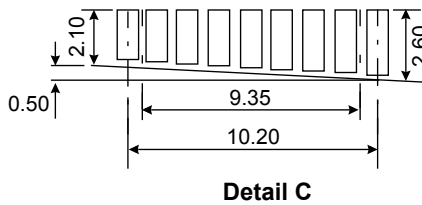
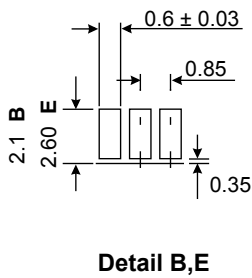
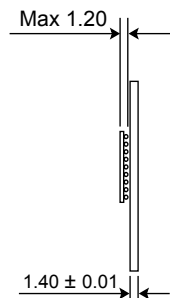
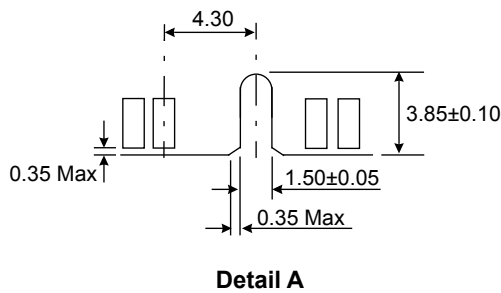
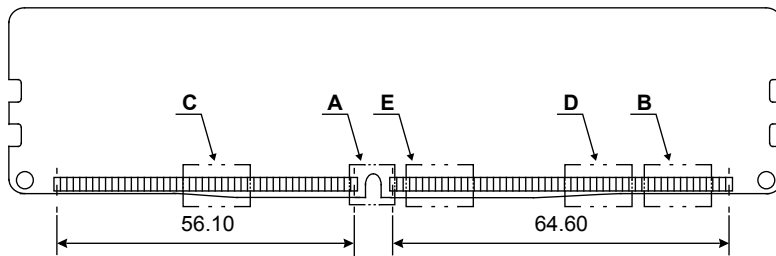
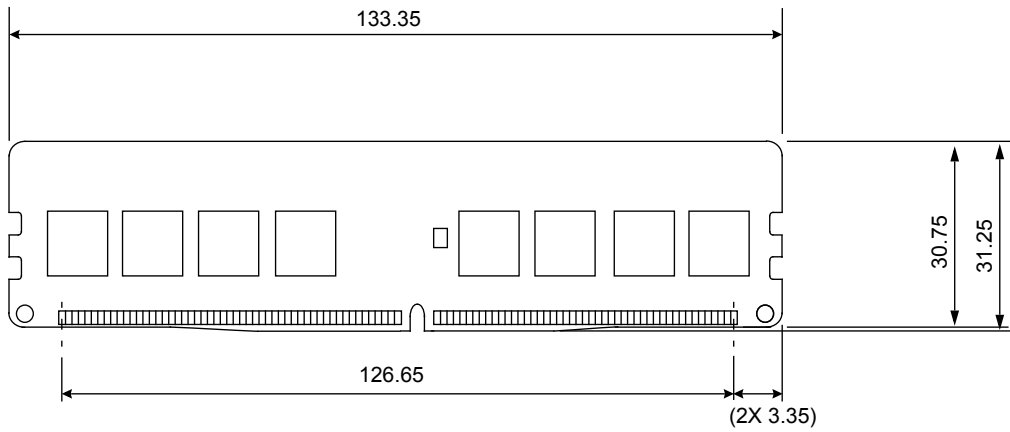

The used device is 1G x8 DDR4 SDRAM, FBGA.
 DDR4 SDRAM Part NO : K4A8G085WB-BC**

NOTE :

1) Tolerances on all dimensions ±0.15 unless otherwise specified.

18.3 1Gx8 based 1Gx64 Module (1 Rank) - M378A1K43BB2

Units : Millimeters

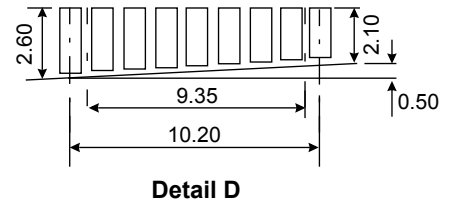
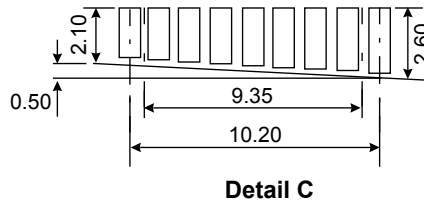
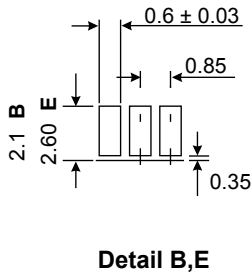
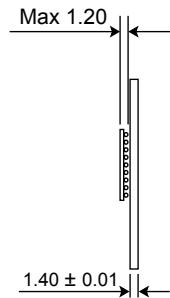
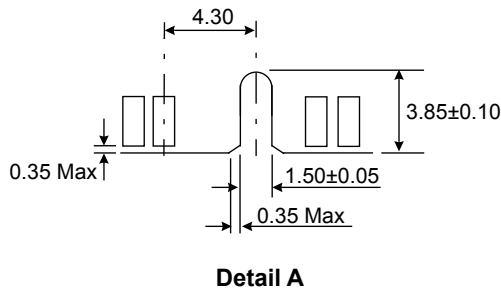
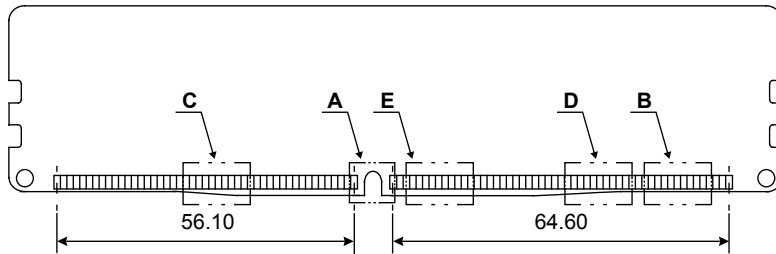
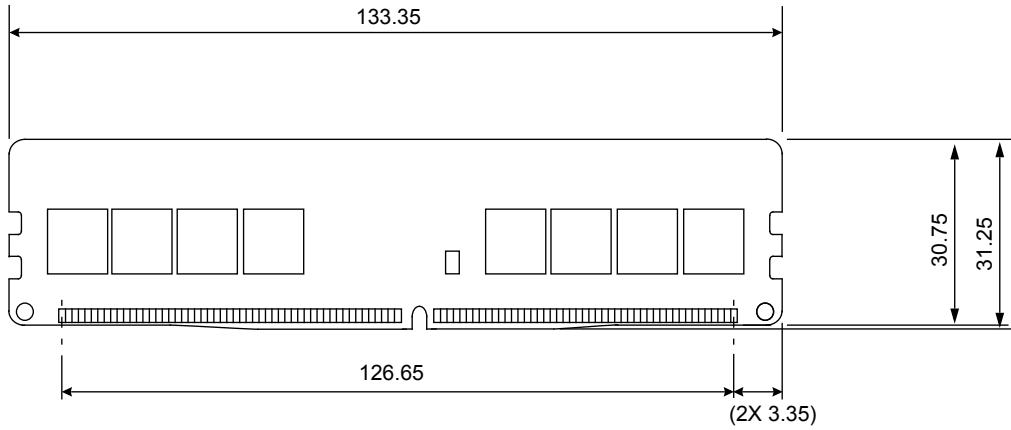

The used device is 1G x8 DDR4 SDRAM, FBGA.
 DDR4 SDRAM Part NO : K4A8G085WB-BC**

NOTE :

1) Tolerances on all dimensions ±0.15 unless otherwise specified.

18.4 1Gx8 based 2Gx64 Module (2 Ranks) - M378A2K43BB1

Units : Millimeters

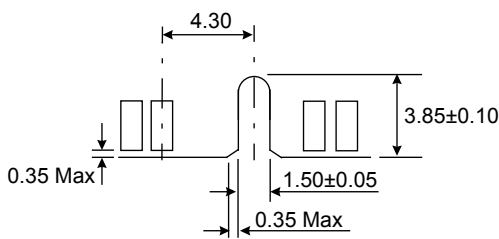
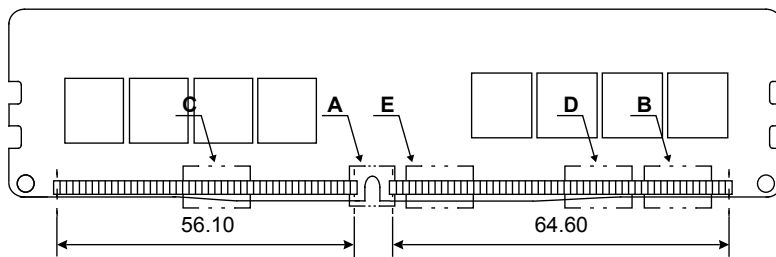
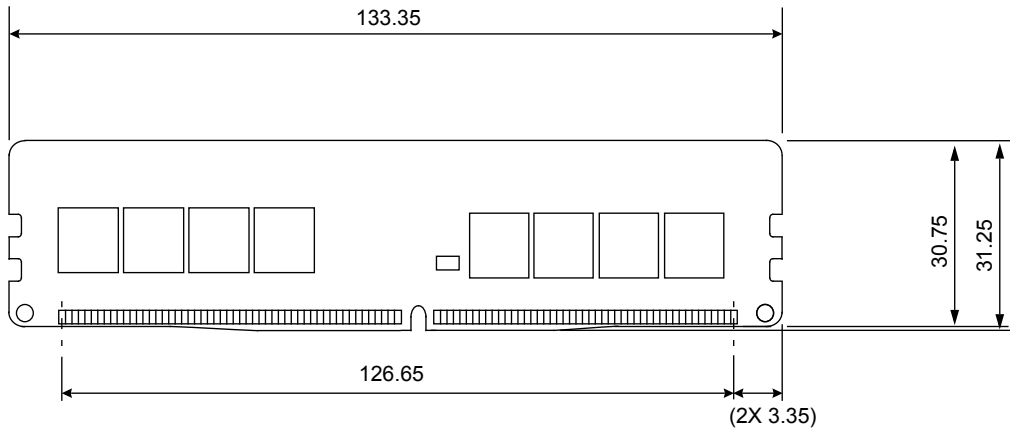

Detail A

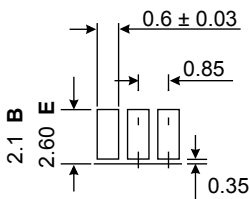
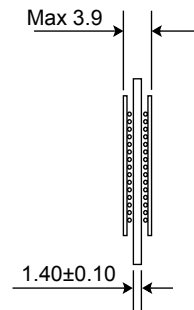

Detail B,E

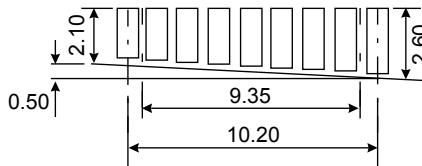

Detail C

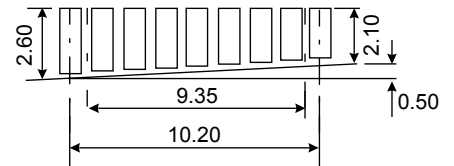

Detail D

The used device is 1G x8 DDR4 SDRAM, FBGA.
 DDR4 SDRAM Part NO : K4A8G085WB-BC**

NOTE :

1) Tolerances on all dimensions ±0.15 unless otherwise specified.